

Top View
Fixture Type B



MRS



XWM



LAD

Label	CalcType	Units	Avg	Max	Min	Avg/Min	Max/Min
ALL CALCS @ 4' ABOVE GRADE	Illuminance	Fc	0.58	33.3	0.0	N.A.	N.A.
PROPERTY LINE	Illuminance	Fc	0.13	1.5	0.0	N.A.	N.A.
PROPERTY LINE AGAINST BUILDING	Illuminance	Fc	2.84	8.2	0.0	N.A.	N.A.
WALKWAY BEHIND BLDG	Illuminance	Fc	5.76	11.3	0.0	N.A.	N.A.
INTERIOR LDT	Illuminance	Fc	3.37	33.3	0.0	N.A.	N.A.
WETLANDS AREA	Illuminance	Fc	0.00	0.1	0.0	N.A.	N.A.

Symbol	Qty	Label	Arrangement	Description	Mounting Height	LLD	LLF	Arr. Lum. Lumens	Arr. Watts
—	1	A	Single	MRS-LED-09L-SIL-FT-50-70CRI-IL-SINGLE	22'	1.000	1.000	6024	63
+	3	B	D180° 2RTD	MRS-LED-09L-SIL-(1)FT-L(1)FT-R-50-70CRI-IL-D180RDT	22'	1.000	1.000	12048	126
—	1	C	Single	MRS-LED-06L-SIL-4-50-70CRI-IL-SINGLE	22'	1.000	1.000	3682	39
⊕	10	S	Single	LAD4-LED-24L-40-WF-TR4R-SF-HAZ	14'	1.000	1.000	2264	22.2
+	6	W	Single	XWS-LED-08L-SIL-FT-50-70CRI	14'	1.000	1.000	8207	61
+	1	W1	Single	XWS-LED-08L-SIL-FT-50-70CRI	8'	1.000	1.000	8207	61
+	7	W2	Single	XWS-LED-05L-SIL-2-50-70CRI	14'	1.000	1.000	4970	35

PHOTOMETRIC EVALUATION
NOT FOR CONSTRUCTION

Based on the information provided, all dimensions and luminaire locations shown represent recommended positions. The engineer and/or architect must determine the applicability of the layout to existing or future field conditions.

This lighting plan represents illumination levels calculated from laboratory data taken under controlled conditions in accordance with the Illuminating Engineering Society (IES) approved methods. Actual performance of any manufacturer's luminaires may vary due to changes in electrical voltage, tolerance in lamps/LED's and other variable field conditions. Calculations do not include obstructions such as buildings, curbs, landscaping, or any other architectural elements unless noted. Fixture nomenclature noted does not include mounting hardware or poles. This drawing is for photometric evaluation purposes only and should not be used as a construction document or as a final document for ordering product.

Total Project Watts
Total Watts = 1374

TONKIN LAMBORGHINI
WILSONVILLE, OR

1888 ALLIANCE BL. CINCINNATI, OH 45244 USA
(513) 793-2008 • FAX (513) 793-9107

LIGHTING PROPOSAL LD-159992-1

BY/CHK	DATE:4/10/24	REV:4/17/24	SHEET 1 OF 1
--------	--------------	-------------	--------------

SCALE: 1"=30'



6" Architectural Downlight (LAD6)

New Construction



OVERVIEW

Lumen Package (lm)	1,100 - 4,200
Wattage Range (W)	14 - 42
Efficacy Range (LPW)	92 - 116
Weight lbs (kg)	9 (4.1)

QUICK LINKS

[Ordering Guide](#)
[Performance](#)
[Photometrics](#)
[Dimensions](#)

FEATURES & SPECIFICATIONS

Optical System

- LED source provides superior lumen output with maximum visual comfort.
- Tailored spot, narrow flood, flood and wide flood beam optics designed for glare free illumination.
- Choice of flanged or flangeless spun reflector utilizing heavy gauge highly reflective diffuse anodized aluminum to deliver low glare, even illumination of the space.
- Reflectors are retained with three retention clips holding the flange tight to the finished ceiling surface.
- Minimum CRI of 80.

Electrical

- High-performance driver features over-voltage, under voltage, short-circuit and over temperature protection.
- 0 - 10V dimming (1% - 100%) standard.
- Standard Universal Voltage (120-277 Vac) Input 50/60 Hz.
- L70 Calculated Life: > 50k Hours projected @ 25°C per IESNA TM-21-11.
- Total harmonic distortion: <20%.
- Power factor: >.90.
- Input power stays constant over life.
- Driver can be accessed from below plenum for servicing.

- High-efficacy LEDs with integrated circuit board mount directly to an extruded aluminum heatsink to maximize heat dissipation and promote long life.
- Remote Emergency Battery (120-277V) is available to meet critical life safety lighting requirements. The 90-minute battery provides 7.8watts constant power to the LED system, ensuring code compliance. To calculate light output during emergency mode(EM battery 7.8 watts x LPW of fixture being powered - see spec sheet). Detailed wiring diagram and installation instructions can be located on the website..

Controls

- 0 - 10V dimming standard.
- Compatible with most 0-10V dimmers
- Compatible with LSI AirLink® Blue for networked controls
- See controls table for more information

New Construction Housing/ Plaster Frame

- Designed for use in non-insulated ceiling where insulation must be kept a minimum of 3" from the fixture.
- Junction box listed for (8) #12 AWG (four in, four out) 90°C conductors and thru branch wiring.
- Junction box contains (5) 1/2" knockouts with trade pry-out slots and (4) Romex cable clamp knockouts.

- Accommodates ceiling thickness up to 1.5".
- Plaster frame with collar is designed with 20-gauge colled rolled steel, black-painted
- Universal mounting brackets provide up to 5" vertical adjustment and accepts 1/2" EMT conduit.
- Additional channel bar, nailer bar and suspended ceiling accessories available. See accessories.
- Frame kit can be ordered separately for new construction build.

Installation

- Additional channel bar, nailer bar and suspended ceiling accessories available to accommodate a variety of ceiling types.

Warranty

- LSI luminaires carry a 5-year limited warranty. Refer to <https://www.lsicorp.com/resources/terms-conditions-warranty/> for more information.

Listings

- cETLus Listed to UL 1598 and UL 8750 standards for 25°C Ambient applications
- RoHS Compliant.
- EMI/RFI compliant with FCC 47CFR Part 15 Class B Consumer limits and Class A Commercial & Industrial.
- Damp location rated.
- Wet location rated with regressed lens.
- Title 24 Compliant.

6" Architectural Downlight (LAD6) New Construction

Type: _____

 Have questions? Call us at (800) 436-7800

ORDERING GUIDE

[Back to Quick Links](#)

TYPICAL ORDER EXAMPLE: LAD6 LED 25L UNV DIM1 35 NF TR6R HAZ							
Prefix	Light Source	Lumen Package	Voltage	Driver	Color Temperature	CRI ²	Beam Optics ³
LAD6 - 6" New Construction ¹	LED	14L - 1,400 Lumens 25L - 2,500 Lumens 32L - 3200 Lumens 41L - 4100 Lumens	UNV - 120 - 277V	DIM1 - Dims to 1% (0-10V dimming)	27 - 2700K 30 - 3000K 35 - 3500K 40 - 4000K	Blank - 80 min.	SP - Spot NF - Narrow Flood FL - Flood WF - Wide Flood
Reflector			Finish				
Self-flanged	TR6R - Open Reflector		SF HAZ - Haze semi- diffused				
			SF SPC - Specular clear				
	TR6RWW - Wall Wash ⁴		SF HAZ - Haze semi-diffused				
Flangeless (Ships standard w/ white plastic trim ring)	TR6R - Open Reflector		HAZ - Haze semi-diffused, white trim ring				
			SPC - Specular clear, white trim ring				
	TR6RWW - Wall Wash ⁴		HAZ - Haze semi-diffused wall wash reflector, white trim ring				
	TR6B - Baffle		HAZ - Haze semi-diffused Reflector			WH - White baffle and white trim ring	
						BLK - Black Baffle and white trim ring	
	TR6BL - Baffle w/ Regressed Lens ⁶		HAZ - Haze semi-diffused reflector			WH - White baffle and white trim ring	
		SPC - Specular clear			BLK - Black Baffle and white trim ring		
TR6RL - Regressed Lens ⁶		HAZ - Haze semi-diffused reflector w/ specular clear regressed lens and white trim ring					
		SPC - Specular clear reflector w/ specular clear regressed lens and white trim ring					



Need more information?
Click here for our glossary

Have additional questions?
Call us at (800) 436-7800



ACCESSORY ORDERING INFORMATION

Part Number	Description
616105	WH - White metal trim ring (only compatible w/ flangeless trims)
205599	C27 - 27" channel bars (pair)
287522	C52 - 52" channel bars (pair)
345989	NB - Nailer bar kt (set of 4)
234808	SCIK - Suspended ceiling installation kit (set of 4 channel bars & 4 T-grid clips)
647671	BL1 - Black metal trim ring
778196	Remote Mount Battery
786277	Remote Battery with Grid Mount Kit ⁷
687986	New Construction Frame Kit-1 pack
791427	New Construction Frame Kit-2 pack
791429	New Construction Frame Kit-1 pack with Self-Diagnostic EM
791430	New Construction Frame Kit-2 pack with Self-Diagnostic EM
791431	T-Grid Bracket for EM ⁸

1 Housing can ship ahead of the light engine and reflector.

2 90 CRI requires 55 day leadtime & 100 MOQ; Consult Factory.

3 Refer to IES Files for Beam Spread.

4 Self-flanged TR6RWW wall wash reflector comes with 40° integrated optic; additional beam optics not compatible.

5 Flangeless TR6RFL frosted floating lens comes with integrated white metal trim; accessory white metal trim ring not required.

6 Regressed lens trims are wet location listed. All other trims are rated for damp location.

7 For complete fixture with remote mount EM for T-Grid install, order remote battery with grid mount kit.

8 For new construction frame kit with EM for T-Grid install, order T-Grid bracket separately.

6" Architectural Downlight (LAD6) New Construction

Type : _____

 Have questions? Call us at (800) 436-7800

PERFORMANCE

[Back to Quick Links](#)

DELIVERED LUMENS*										
Lumen Package	Distribution	2700K CCT		3000K CCT		3500K CCT		4000K CCT		Wattage
		Delivered Lumens	Efficacy	Delivered Lumens	Efficacy	Delivered Lumens	Efficacy	Delivered Lumens	Efficacy	
14L	SP	1184	84.6	1184	84.6	1467	104.8	1467	104.8	14
	NF	1156	82.6	1156	82.6	1432	102.3	1432	102.3	
	FL	1152	82.3	1152	82.3	1428	102.0	1428	102.0	
	WF	1079	77.1	1079	77.1	1337	95.5	1337	95.5	
25L	SP	2066	93.9	2066	93.9	2560	116.4	2560	116.4	22
	NF	2017	91.7	2017	91.7	2499	113.6	2499	113.6	
	FL	2011	91.4	2011	91.4	2492	113.3	2492	113.3	
	WF	1883	85.6	1883	85.6	2333	106.0	2333	106.0	
32L	SP	2665	83.3	2665	83.3	3302	103.2	3302	103.2	32
	NF	2602	81.3	2602	81.3	3224	100.8	3224	100.8	
	FL	2594	81.1	2594	81.1	3215	100.5	3215	100.5	
	WF	2429	75.9	2429	75.9	3010	94.1	3010	94.1	
41L	SP	3409	81.2	3409	81.2	4224	100.6	4224	100.6	42
	NF	3328	79.2	3328	79.2	4123	98.2	4123	98.2	
	FL	3318	79.0	3318	79.0	4112	97.9	4112	97.9	
	WF	3107	74.0	3107	74.0	3849	91.6	3849	91.6	

*Electrical Data at 25C (77F)/ Actual Wattage may differ +/-10%

ELECTRICAL DATA (AMPS)*				
Lumen Package	120V	208V	240V	277V
14L	0.12	0.07	0.06	0.05
25L	0.18	0.11	0.09	0.08
32L	0.27	0.15	0.13	0.12
41L	0.35	0.20	0.18	0.15

*LED Chips are frequently updated therefore values may change.
Data is based on Haze Reflector.

6" Architectural Downlight (LAD6) New Construction

Type: _____

 Have questions? Call us at (800) 436-7800

PHOTOMETRICS

[Back to Quick Links](#)

Luminaire photometry has been conducted by a NVLAP accredited testing laboratory in accordance with IESNA LM-79-08. As specified by IESNA LM-79-08 the entire luminaire is tested as the source resulting in a luminaire efficiency of 100%.

See the individual product page on <https://www.lsicorp.com/> for detailed photometric data.

LAD6-LED-25L-35-SP-TR6R-SF-HAZ

Lumens: 2,560

Watts: 22.2

Efficacy: 115

ZONAL LUMEN SUMMARY		
Zone	Lumens	%Fixture
0-10	797	31.2%
10-20	766	29.9%
20-30	611	23.9%
30-40	315	12.3%
40-50	51	2.0%
50-60	14	0.5%
60-70	3	0.1%
70-80	1	0.0%
80-90	1	0.0%
90-100	0	0.0%
0-180	2,560	100.0%

CANDELA TABLE	
Degree Vertical	Candela
0	11,901
5	10,123
10	5,266
15	2,578
20	1,645
25	1,309
30	1,091
35	426
40	128
45	60
50	32
55	14
60	6
65	3
70	1
75	1
80	0
85	1
90	0

Polar Candela Distribution

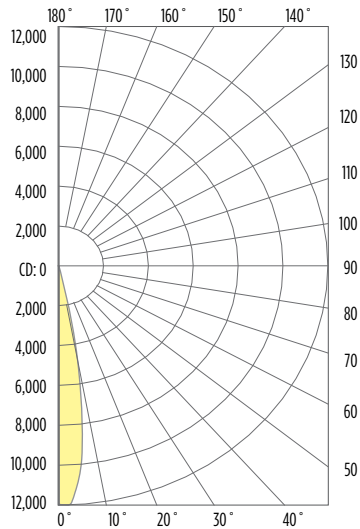

Illuminance at a Distance

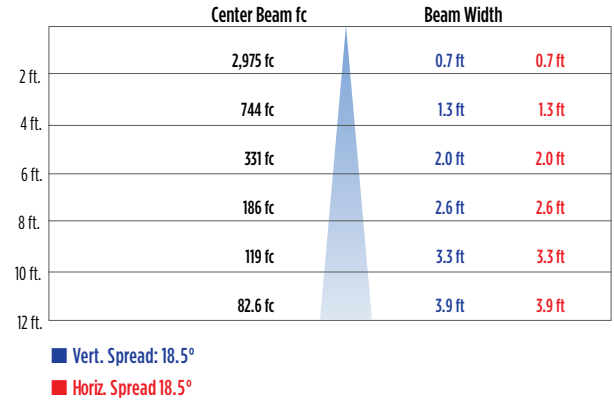

LAD6-LED-25L-35-NF-TR6R-SF-HAZ

Lumens: 2,499

Watts: 22.2

Efficacy: 113

ZONAL LUMEN SUMMARY		
Zone	Lumens	%Fixture
0-10	445	17.8%
10-20	831	33.2%
20-30	755	30.2%
30-40	375	15.0%
40-50	71	2.9%
50-60	17	0.7%
60-70	4	0.1%
70-80	1	0.1%
80-90	1	0.0%
90-100	0	0.0%
0-180	2,499	100.0%

CANDELA TABLE	
Degree Vertical	Candela
0	5,233
5	4,982
10	4,023
15	2,984
20	2,165
25	1,607
30	1,246
35	493
40	180
45	82
50	40
55	16
60	7
65	3
70	2
75	1
80	1
85	0
90	0

Polar Candela Distribution

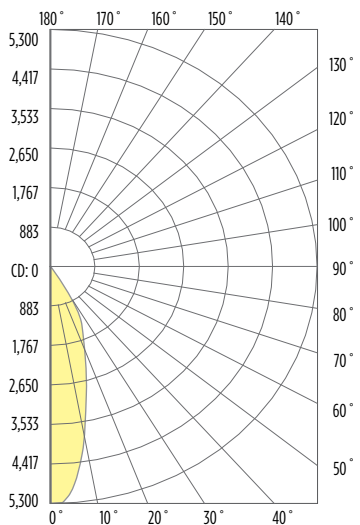

Illuminance at a Distance

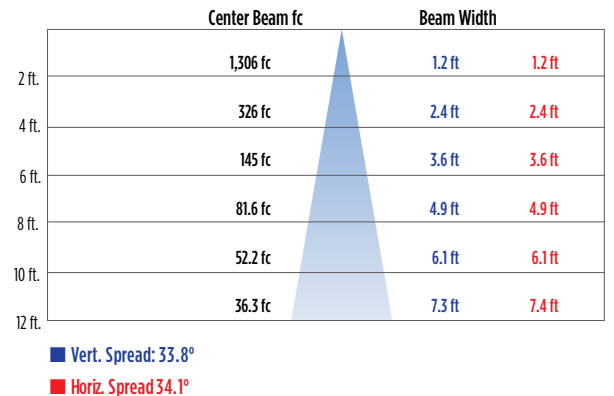

6" Architectural Downlight (LAD6) New Construction

Type: _____

 Have questions? Call us at (800) 436-7800

PHOTOMETRICS

[Back to Quick Links](#)

LAD6-LED-25L-35-FL-TR6R-SF-HAZ

Lumens: 2,492

Watts: 22.2

Efficacy: 112

ZONAL LUMEN SUMMARY		
Zone	Lumens	%Fixture
0-10	304	12.2%
10-20	773	31.0%
20-30	8475	34.0%
30-40	443	17.8%
40-50	99	4.0%
50-60	19	0.8%
60-70	4	0.2%
70-80	2	0.1%
80-90	1	0.0%
90-100	0	0.0%
0-180	2,492	100.0%

CANDELA TABLE	
Degree Vertical	Candela
0	3,271
5	3,236
10	3,071
15	2,780
20	2,315
25	1,812
30	1,415
35	624
40	257
45	120
50	52
55	18
60	7
65	4
70	2
75	1
80	1
85	0
90	0

Polar Candela Distribution

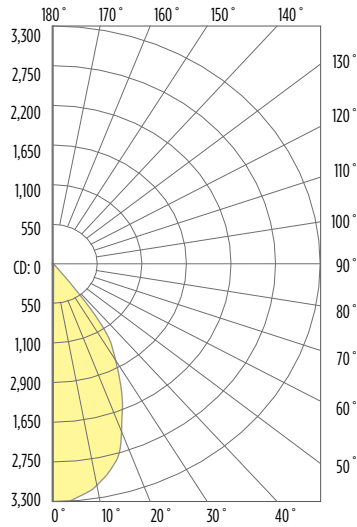

Illuminance at a Distance

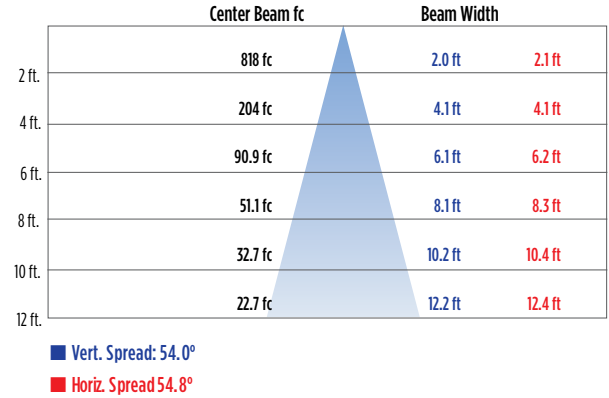

LAD6-LED-25L-35-WF-TR6R-SF-HAZ

Lumens: 2,333

Watts: 22.2

Efficacy: 105

ZONAL LUMEN SUMMARY		
Zone	Lumens	%Fixture
0-10	237	10.5%
10-20	617	27.2%
20-30	722	31.9%
30-40	405	17.9%
40-50	219	9.7%
50-60	53	2.3%
60-70	9	0.4%
70-80	2	0.1%
80-90	0	0.0%
90-100	0	0.0%
0-180	2,264	100.0%

CANDELA TABLE	
Degree Vertical	Candela
0	3,826
5	3,844
10	3,654
15	3,182
20	2,513
25	1,770
30	852
35	391
40	206
45	104
50	45
55	17
60	6
65	3
70	2
75	1
80	1
85	0
90	0

Polar Candela Distribution

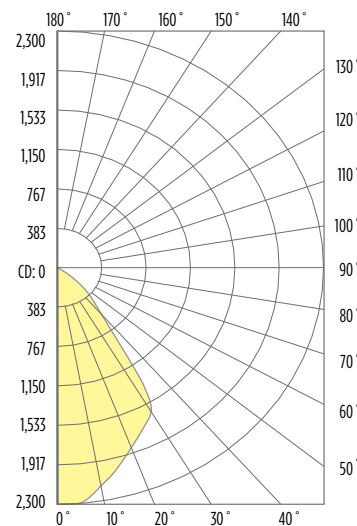

Illuminance at a Distance

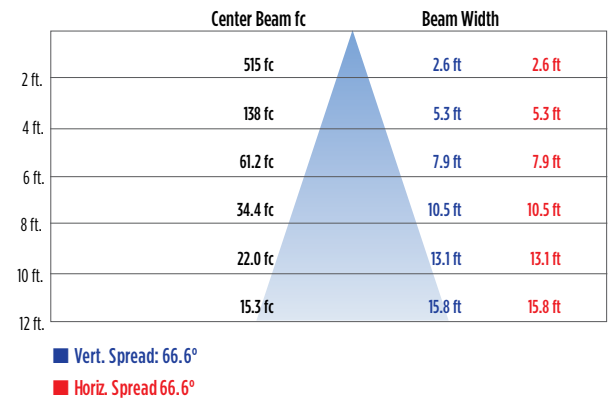

6" Architectural Downlight (LAD6) New Construction

Type: _____

 Have questions? Call us at (800) 436-7800

PRODUCT DIMENSIONS

[Back to Quick Links](#)

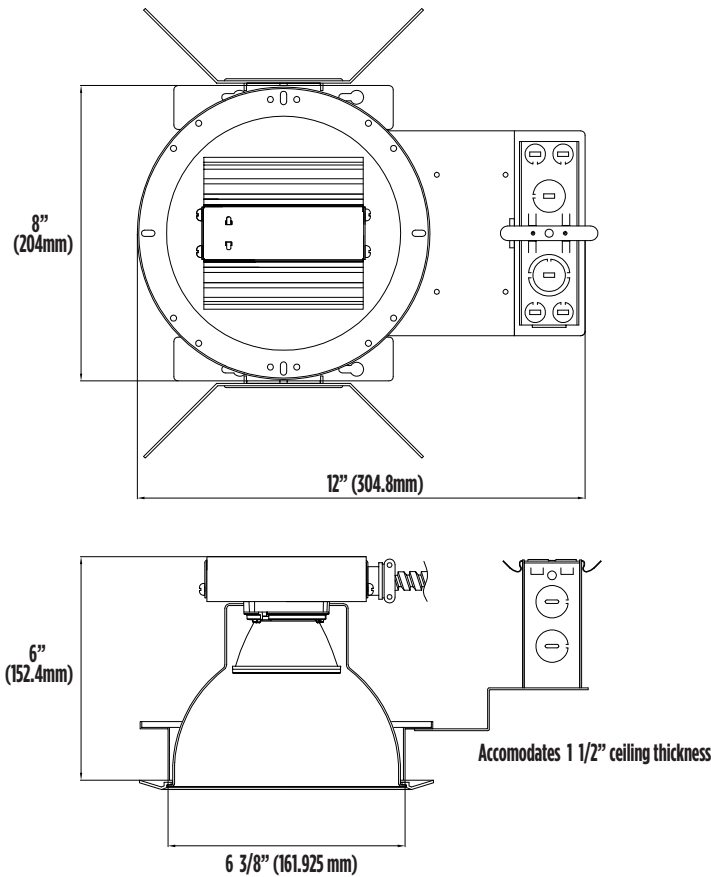

6" RECESSED DOWNLIGHT REFLECTORS

[Back to Quick Links](#)



TR6R - Open Reflector

Self-Flange or Flangeless
HAZ - Haze semi-diffused
SPC - Specular clear



TR6B - Baffle

Flangeless
HAZ - Haze semi-diffused reflector
Choice of white or black baffle



TR6RL - Regressed Lens w/ Specular Clear Reflector

Flangeless
HAZ - Haze semi-diffused
SPC - Specular clear
Wet Location Listed



TR6BL - Baffle w/ Regressed Lens

Flangeless
HAZ - Haze semi-diffused
SPC - Specular clear
Choice of white or black baffle
Wet Location listed



Catalog #: _____

Project: _____

Prepared By: _____

Date: _____

Mirada Small Area (MRS)

Turtle friendly LED Area Light



IP66 IK08



OVERVIEW

Lumen Package	2,000 - 4,000
Wattage Range	36 - 93
Efficacy Range (LPW)	39 - 73
Fixture Weight lbs (kg)	20 (9.1)

QUICK LINKS

[Ordering Guide](#)[Performance](#)[Photometrics](#)[Dimensions](#)

FEATURES & SPECIFICATIONS

Construction

- Rugged die-cast aluminum housing contains factory prewired driver and optical unit. Cast aluminum wiring access door located underneath.
- Fixtures are finished with LSI's DuraGrip® polyester powder coat finishing process. The DuraGrip finish withstands extreme weather changes without cracking or peeling. Other standard LSI finishes available. Consult factory.
- Shipping weight: 27 lbs in carton.

Optical System

- State-of-the-Art one piece silicone optic sheet delivers industry leading optical control with an integrated gasket to provide IP66 rated seal.
- Proprietary silicone refractor optics provide exceptional coverage and uniformity in distribution types 2, 3, 5W, and FT.
- Silicone optical material does not yellow or crack with age and provides a typical light transmittance of 93%.
- Zero uplight.
- Available in narrow band amber with peak intensity at 596nm.
- Integral louver (IL) and integral half louver (IH) options available for enhanced backlight control.
- External shielding available for blocking visibility from any side of the luminaire.

Electrical

- High-performance driver features over-voltage, under-voltage, short-circuit and over temperature protection.
 - 0-10V dimming (10% - 100%) standard.
 - Standard Universal Voltage (120-277 VAC) Input 50/60 Hz or optional High Voltage (347-480 VAC).
 - Total harmonic distortion: <20%
 - Operating temperature: -40°C to +50°C (-40°F to +122°F).
 - Power factor: >.90
 - Input power stays constant over life.
 - Field replaceable 10kV surge protection device meets a minimum Category C Low operation (per ANSI/IEEE C62.41.2).
 - LEDs mounted to metal-core circuit board to maximize heat dissipation
 - Driver is fully encased in potting material for moisture resistance and complies with FCC standards. Driver and key electronic components can easily be accessed.
- ### Controls
- Optional integral passive infrared Bluetooth™ motion and photocell sensor. Fixtures operate independently and can be commissioned via iOS or Android configuration app.
 - LSI's AirLink™ wireless control system options reduce energy and maintenance costs while optimizing light quality 24/7.

poles.

- A single fastener secures the hinged door, underneath the housing and provides quick & easy access to the electrical compartment.
- Included terminal block accepts up to 12 ga. wire.
- Utilizes LSI's traditional B3 drill pattern.

Warranty

- LSI luminaires carry a 5-year limited warranty. Refer to <https://www.lsicorp.com/resources/terms-conditions-warranty/> for more information.

Listings

- Listed to UL 1598 and UL 8750.
- Meets Buy American Act requirements.
- IDA compliant.
- Suitable for wet locations.
- IP66 rated Luminaire per IEC 60598-1.
- 3G rated for ANSI C136.31 high vibration applications are qualified.
- IK08 rated luminaire per IEC 66262 mechanical impact code.

Installation

- Designed to mount to square or round



ORDERING GUIDE

[Back to Quick Links](#)

TYPICAL ORDER EXAMPLE: MRS LED 4L SIL FT L UNV DIM AMT ALBCS1 BLK IH

Prefix	Light Source	Lumen Package	Lens	Distribution	Orientation ²	Voltage	Driver
MRS - Mirada Small Area Light	LED	2L - 2,000 lms 4L - 4,000 lms Custom Lumen Packages ¹	SIL - Silicone	2 - Type 2 3 - Type 3 5W - Type 5 Wide FT - Forward Throw	(blank) - standard L - Optics rotated left 90° R - Optics rotated right 90°	UNV - Universal Voltage (120-277V) HV - High Voltage (347-480V)	DIM - 0-10V Dimming (0-10%)

Color Temp	Controls (Choose One)	Finish	Options
AMT - Narrow Band Amber	(Blank) - None Wireless Controls System ALSC - AirLink Synapse Control System ALSCS2 - AirLink Synapse Control System with 12-20' MH Motion Sensor ALSCS4 - AirLink Synapse Control System with 20-40' MH Motion Sensor ALBCS1 - AirLink Blue Wireless Motion & Photo Sensor Controller (8-24' MH) ALBCS2 - AirLink Blue Wireless Motion & Photo Sensor Controller (25-40' MH) Stand-Alone Controls EXT - 0-10v Dimming leads extended to housing exterior CR7P - 7 Pin Control Receptacle ANSI C136.41 ³ IMSBTL1 - Integral Bluetooth™ Motion and Photocell Sensor (8-24' MH) ⁴ IMSBTL2 - Integral Bluetooth™ Motion and Photocell Sensor (25-40' MH) ⁴	BLK - Black BRZ - Dark Bronze GMG - Gun Metal Gray GPT - Graphite MSV - Metallic Silver PLP - Platinum Plus SVG - Satin Verde Green WHT - White	(Blank) - None IH - Integral Half Louver (Moderate Spill Light Cutoff) ² IL - Integral Louver (Sharp Spill Light Cutoff) ²



Need more information?
Click here for our glossary

Have additional questions?
Call us at (800) 436-7800



Accessory Ordering Information⁵

CONTROLS ACCESSORIES	
Description	Order Number
Twist Lock Photocell (120V) for use with CR7P	122514
Twist Lock Photocell (208-277) for use with CR7P	122515
Twist Lock Photocell (347V) for use with CR7P	122516
Twist Lock Photocell (480V) for use with CR7P	1225180
AirLink 5 Pin Twist Lock Controller	661409
AirLink 7 Pin Twist Lock Controller	661410
Shorting Cap for use with CR7P	149328

SHIELDING OPTIONS	
Description	Order Number
Mirada Small	See Shielding Guide
Mirada Medium	
Mirada Large	
Zone Medium	
Zone Large	
Slice Medium	

1. Custom lumen and wattage packages available, consult factory. Values are within industry standard tolerances but not DLC listed.
2. Not available on "Type 5W" distribution.
3. Control device or shorting cap must be ordered separately. See Accessory Ordering Information.
4. IMSBT is field configurable via the LSI app that can be downloaded from your smartphone's native app store.
5. Accessories are shipped separately and field installed.
6. "CLR" denotes finish. See Finish options.

ACCESSORIES

[Back to Quick Links](#)

MOUNTING ACCESSORIES		SHIELDING, POLES & MISC. ACCESSORIES		
Side Arm	Universal Mounting Bracket Mounts to $\geq 3"$ square or round (tapered/straight) poles with (2) mounting hole spaces between 3.5" to 5" Part Number: BKA UMB CLR		Integral Louver Field Install Integral Louver provides maximum backlight control by shielding each individual row of LEDs Part Number: 763445	
	Quick Mount Plate True one person installation to existing/new construction poles with hole spaces between 2.4 to 4.6" Part Number: BKS POM B3B5 XX CLR		Integral Half Louver Field Install Integral Half Louver provides great backlight control without impacting front side distribution. Part Number: 763446	
	15° Tilt Quick Mount Plate True one person installation to existing/new construction poles with hole spaces between 2.4 to 4.6" Part Number: BKS PQ15 B3B5 XX CLR		External Shield External shield blocks view of light source from anyside of luminaire, additional shielding configurations available Part Number: 783607BLK (3") / 776538BLK (6")	
Tenon / Slipfitter	Adjustable Slipfitter Mounts onto a 2" (51mm) IP, 2.375" (60mm) O.D. tenon and provides 180° of tilt (max 45° above horizontal) Part Number: BKA ASF CLR		Square Poles 14 - 39' steel and aluminum poles in 4", 5" and 6" sizes for retrofit and new construction Part Number: 4SQ/5SQ/6SQ	
	Square Tenon Top Mounts onto a 2" (51mm) IP, 2.375" (60mm) O.D. tenon and allows for mounting up to 4 luminaires Part Number: BKA XNM *			
	Square Internal Slipfitter Mounts inside 4" or 5" square pole and allows for mounting up to 4 luminaires Part Number: BKA X_ISF * CLR			
Wall Mount / Wood Pole	Wall Mount Bracket Mounts onto vertical wall surface (hardware/anchors not included) Part Number: BKS XBO WM CLR		Round Poles 10 - 30' steel and aluminum poles in 4" and 5" sizes for retrofit and new construction Part Number: 4RP/5RP	
	Wood Pole Bracket Mounts onto wooden poles (6" minimum OD, hardware/anchors not included) Part Number: BKS XBO WP CLR			
			Tapered Poles 20' - 39' steel and aluminum poles for retrofit and new construction Part Number: RTP	
			Bird Spikes 10' Linear Bird Spike Kit, 4' recommended per luminaire, includes silicone adhesive and application tool Part Number: 736795	

Replace CLR with paint finish description
 Replace XX with SQ for square pole or RD for round pole ($\geq 3"$ OD)
 Replace * with S (Single), D180 (Double @180°), D90 (Double @90°), T90 (Triple), Q90 (Quad)
 Replace _ with 4 (4" square pole) or 5 (5" square pole)

OPTICS ROTATION

Top View

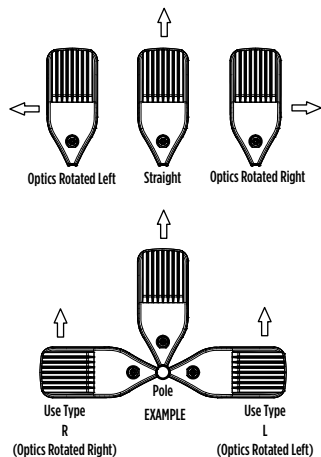

ACCESSORIES/OPTIONS

Integral Louver (IL) and House-Side Shield (IH)

Integral louver (IL) and half louver (IH) accessory shields available for improved backlight control without sacrificing street side performance. LSI's Integral Louver (IL) and Integral House-Side Shield (IH) options deliver backlight control that significantly reduces spill light behind the poles for applications with pole locations close to adjacent properties. The design maximizes forward reflected light while reducing glare, maintaining the optical distribution selected, and most importantly eliminating light trespass. Both options rotate with the optical distribution.

Luminaire Shown with Integral Louver (IL)



Luminaire Shown with IMSBTL Option



7 Pin Photoelectric Control

7-pin ANSI C136.41-2013 control receptacle option available for twist lock photocontrols or wireless control modules. Control accessories sold separately. Dimming leads from the receptacle will be connected to the driver dimming leads (Consult factory for alternate wiring).

Luminaire Shown with CR7P



PERFORMANCE

[Back to Quick Links](#)

DELIVERED LUMENS*					
Lumen Package	Distribution	Narrow Band Amber			Wattage
		Delivered Lumens	Efficacy	BUG Rating	
2L	2	2557	72	B1-U0-G1	36
	3	2599	73	B1-U0-G1	
	5W	2459	69	B2-U0-G1	
	FT	2516	70	B1-U0-G1	
4L	2	3761	40	B1-U0-G1	93
	3	3822	41	B1-U0-G1	
	5W	3616	39	B3-U0-G1	
	FT	3699	40	B1-U0-G1	

ELECTRICAL DATA (AMPS)*							
Lumens	Wattage	120V	208V	240V	277V	347V	480V
2L	36	0.30	0.17	0.15	0.13	0.10	0.07
4L	93	0.78	0.45	0.39	0.34	0.27	0.19

*Electrical data at 25°C (77°F). Actual wattage may differ by +/-10%

*LEDs are frequently updated therefore values are nominal.

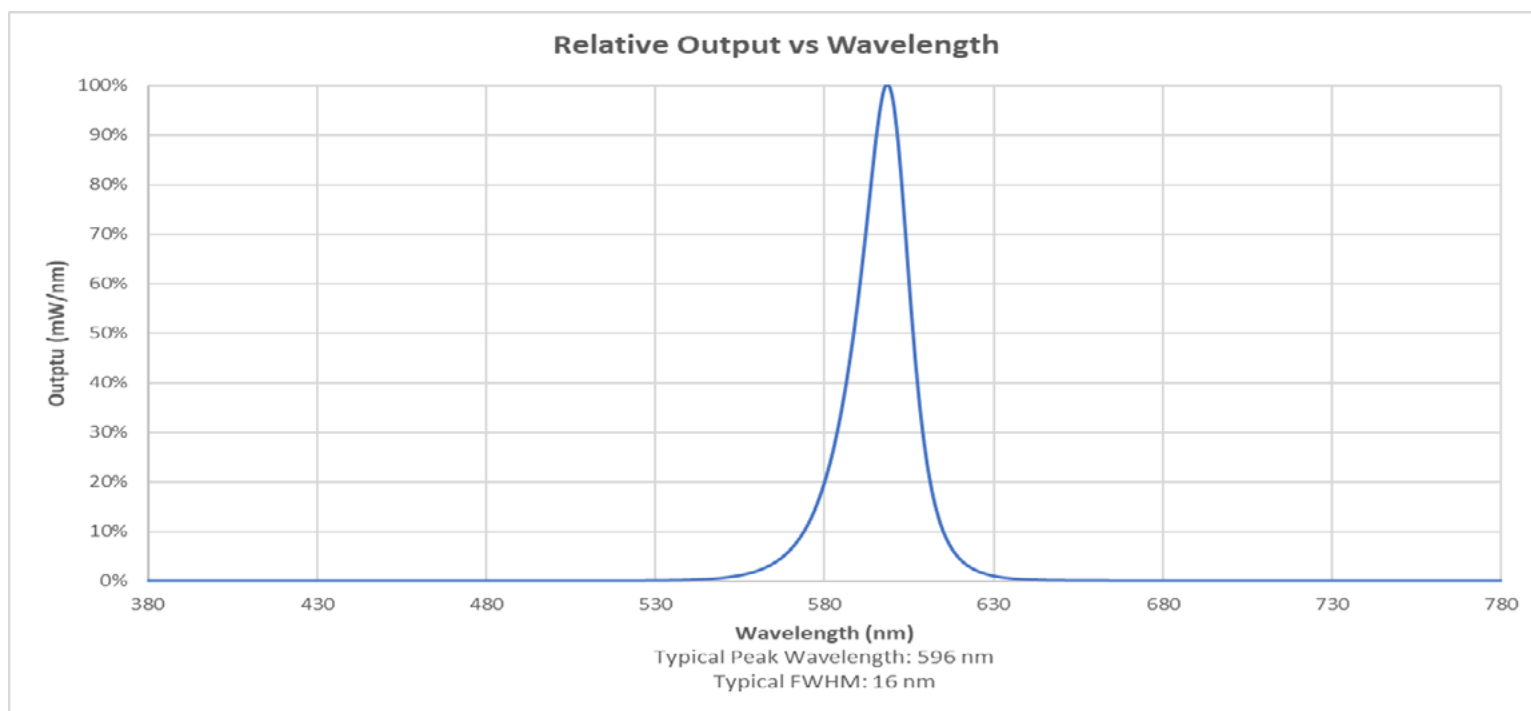

1. Lumen maintenance values at 25°C are calculated per TM-21 based on LM-80 data and in-situ luminaire testing.
2. In accordance with IESNA TM-21-11, Projected Values represent interpolated value based on time durations that are within six times (6X) the IESNA LM-80-08 total test duration (in hours) for the device under testing ((DUT) i.e. the packaged LED chip).
3. In accordance with IESNA TM-21-11, Calculated Values represent time durations that exceed six times NA LM-80-08 total test duration (in hours) for the device under testing ((DUT) i.e. the packaged LED chip).

Mirada Small Area Light (MRS)





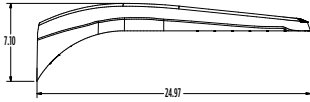
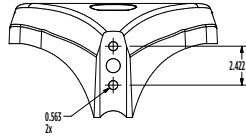
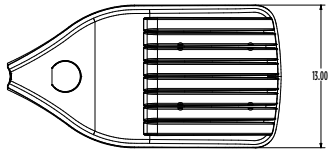

Type: _____

 **Have questions?** Call us at (800) 436-7800

[Back to Quick Links](#)

PRODUCT DIMENSIONS



Tilt Degree		0°	30°	45°	Tilt Degree		0°	30°	45°
	Single	0.5	1.3	1.8		TM90°	1.4	2.3	2.6
	D180°	0.9	1.3	1.8		TM120°	1.4	1.9	2.3
	D90°	0.9	1.8	2.2		O90°	1.4	2.3	2.6

CONTROLS

[Back to Quick Links](#)

Integral Bluetooth™ Motion and Photocell Sensor (IMSBTxL)

Slim low profile sensor provides multi-level control based on motion and/or daylight. Sensor controls 0-10 VDC LED drivers and is IP66 rated for cold and wet locations (-40°F to 167°F). Two unique PIR lenses are available and used based on fixture mounting height. All control parameters are adjustable via an iOS or Android App capable of storing and transmitting sensor profiles.

[Click here to learn more details about IMSBT](#)



LEVITON App



Apple



Android

AirLink Blue (ALBCSx)

Wireless Bluetooth Mesh Outdoor Lighting Control System that provides energy savings, code compliance and enhanced safety/security for parking lots and parking garages. Three key components; Bluetooth wireless radio/sensor controller, Time Keeper and an iOS App. Capable of grouping multiple fixtures and sensors as well as scheduling time-based events by zone. Radio/Sensor Controller is factory integrated into Area/ Site, Wall Mounted, Parking Garage and Canopy luminaires.

[Click here to learn more details about AirLink Blue](#)



AirLink Blue App



Apple

Sensor Sequence of Operations

Standard Programming	On Event	Off Event	On Light Level	Dim Light Level	Daylight Harvesting	Delay To Off	Sensitivity
OMSBTxL/IMSBTxL	Motion	No Motion	100%	N/A	On; Auto Calibration	20 minutes	High
OMS	Motion	No Motion	N/A	N/A	N/A	30 seconds	Auto

Operation	Description
On Event	Trigger that activates lights to turn on; either automatic via motion detected or manually activated via push of button.
Off Event	Trigger that activates lights to turn off; either automatic via no motion detected or manually activated via push of button.
On Light Level	The light level that the fixtures will turn on to when ON EVENT occurs.
Dim Light Level	The light level that the fixtures will dim down to when no motion is detected.
Delay to Dim	The amount of time after which no motion is detected that the fixtures will be triggered to dim down. This sequence is optional, and sensor can be programmed to only trigger the fixture to turn off by entering 100% in this field.
Delay to Off	The amount of time after which no motion is detected that the fixtures will be triggered to turn off. If delay to dim is part of the programmed functionality, this is the amount of time after which no motion is detected after the fixture have already dimmed down.
Sensitivity	The sensitivity can be set to high, medium, low, or auto where applicable. High will detect smaller, simple motions. Low will only detect larger more complex motions. Auto temperature calibration adjusts the PIR sensitivity as ambient temperature rises to increase detection of heat movement through the field of view.



Mirada Small Wall Sconce Silicone (XWS SIL)

Outdoor LED Wall Light



OVERVIEW

Lumen Package (lm)	2,000 - 8,000
Wattage Range (W)	13 - 61
Efficacy Range (LPW)	126 - 162
Weight lbs (kg)	10 (4.5)

QUICK LINKS

[Ordering Guide](#)
[Performance](#)
[Photometrics](#)
[Dimensions](#)

FEATURES & SPECIFICATIONS

Construction

- Rugged die-cast aluminum housing.
- Fixtures are finished with LSI's DuraGrip® polyester powder coat finishing process. The DuraGrip finish withstands extreme weather changes without cracking or peeling. Other standard LSI finishes available. Consult factory.
- Extended housing available with 1/2" threaded hubs for surface conduit and rated wire.
- Standard luminaire shipping weight: TBD lbs in carton.
- Max luminaire shipping weight: 12 lbs in carton (20 lbs w/EH option)

Optical System

- State-of-the-Art one piece silicone optic provides industry leading optical control while also acting as an integrated gasket reducing system complexity and improving fixture reliability.
- Proprietary silicone refractor optics provide exceptional coverage and uniformity in distribution types 2, 3, and FT.
- Silicone optical material does not yellow or crack with age and provides a typical light transmittance of 93%.
- Zero uplight.
- Available in 5000K, 4000K, and 3000K color temperatures per ANSI C78.377.
- Minimum CRI of 70

Electrical

- High-performance driver features over-voltage under-voltage, short-circuit, and over temperature protection.

- 0-10V dimming (10% - 100%) standard.
- Standard Universal Voltage (120-277 VAC) Input 50/60 Hz or optional High Voltage (347-480 VAC).
- L70 Calculated Life: >60k Hours
- Total harmonic distortion (THD): <20%
- Operating temperature: -40°C to +50°C (-40°F to +122°F).
- Power factor (PF): >.90
- Input power stays constant over life.
- Optional 10kV surge protection device meets a minimum Category C Low operation (per ANSI/IEEE C62.41.2).
- High-efficacy LEDs mounted to metal-core circuit board to maximize heat dissipation
- Driver is fully encased in potting material for moisture resistance. Driver complies with FCC standards. Accessible driver and electrical components.
- Optional battery backup provides 90-minutes of constant power to the LED system, ensuring code compliance. A test switch/indicator button is installed on the housing for ease of maintenance. Standard battery rated for 0°C to 50°C with cold weather battery rated for -20°C to 50°C (40°C max for 8L). 120-277V Only.

Controls

- Optional integral passive infrared Bluetooth™ motion. Fixtures operate independently and can be commissioned via iOS or Android configuration app.
- Optional button photocell turns fixtures on and off based on ambient light levels for dusk to dawn lighting.

- LSI's AirLink Blue wireless control system options allow for fixture and motion sensor grouping while reducing energy and maintenance costs.

Installation

- Universal wall mounting plate mounts directly to vertical surface or 4" junction box (octagonal or square).
- Luminaire hinges to the top of the mounting plate and is secured via two flush mount screws that help to conceal the hardware and prevent over tightening during installation.

Warranty

- LSI luminaires carry a 5-year limited warranty. Refer to <https://www.lsicorp.com/resources/terms-conditions-warranty/> for more information.

Listings

- Listed to UL 1598 and UL 8750.
- Meets Buy American Act requirements.
- IDA compliant; with 3000K color temperature selection.
- Title 24 Compliant; see local ordinance for qualification information.
- Suitable for wet locations.
- IP65 rated luminaire per IEC 60598-1.
- IK08 rated luminaire per IEC 66262 mechanical impact code.
- DesignLights Consortium® (DLC) Premium qualified product. Not all versions of this product may be DLC Premium qualified. Please check the DLC Qualified Products List at www.designlights.org/QPL to confirm which versions are qualified.

Mirada Small Wall Sconce Silicone (XWS SIL)

Type : _____

 **Have questions?** Call us at (800) 436-7800

ORDERING GUIDE

[Back to Quick Links](#)

TYPICAL ORDER EXAMPLE: XWS LED 6L SIL FT UNV DIM 40 70CRI ALBCS1 BLK CWBB						
Prefix	Light Source	Lumen Package	Lens	Distribution	Voltage	Driver
XWS - Mirada Small Wall Sconce	LED	2L - 2,000 3L - 3,000 5L - 5,000 6L - 6,000 8L - 8,000 Custom Lumen Packages ¹	SIL - Silicone	2 - Type 2 3 - Type 3 FT - Forward Throw	UNV - Universal Voltage (120-277V) HV - High Voltage (347-480V)	DIM - 0-10v Dimming (0-10%)
Color Temperature	Color Rendering	Controls			Finish	Options
50 - 5000K 40 - 4000K 30 - 3000K	70CRI - 70 CRI	Blank - None Wireless Controls ALBCS1 - AirLink Blue Wireless Motion & Photo Sensor Controller (8-24' mounting height) ² Standalone Controls EXT - 0-10v Dimming leads extended to housing exterior IMSBT1L - Integral Bluetooth™ Motion Sensor 8-24' MH ^{2,3} Button Type Photocells PCI120 - 120V PCI208-277 - 208 -277V PCI347 - 347V			BLK - Black BRZ - Dark Bronze GMG - Gun Metal Gray GPT - Graphite MSV - Metallic Silver PLP - Platinum Plus SVG - Satin Verde Green WHT - White	Blank - None BB - 10w Battery Back-up (0°C) ⁴ CWBB - 10w Cold Weather Battery Backup (-20°C) ⁴ BB20 - 20W Battery Back-up (0°C) ⁴ EH - Extended Housing ⁵ SP1 - 10kV Surge Protection Device



Need more information?
[Click here for our glossary.](#)

Have additional questions?
 Call us at (800) 436-7800



ACCESSORY ORDERING INFORMATION*

Part Number	Description
758274CLR	XWS Extended Housing/Surface Conduit Wiring Box
760159CLR	XWS Spacer Plate/Wiring Box

*Accessories are shipped separately and field installed.

Battery Backup

- Emergency battery system provides 90-minutes of constant power to the LED system, ensuring code compliance.
- A test switch/indicator button is installed on the housing for ease of maintenance.
- 10w battery delivers ~1,500 lumens during emergency mode.
- 20w battery delivers ~3,000 lumens during emergency mode.



Luminaire shown with sensor & battery backup

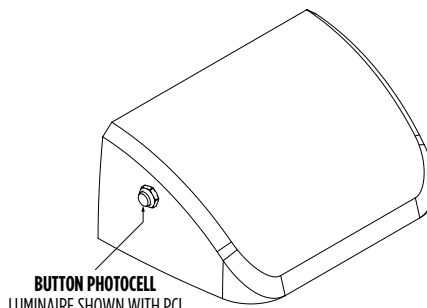

BUTTON PHOTOCELL
LUMINAIRE SHOWN WITH PCI

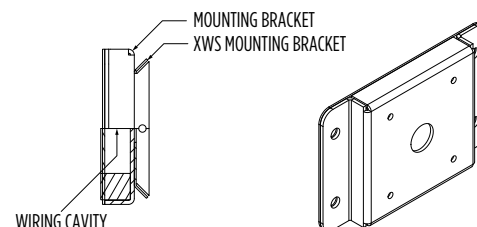

WIRING CAVITY

MOUNTING BRACKET
XWS MOUNTING BRACKET

1 Custom lumen and wattage packages available, consult factory. Values are within industry standard tolerances but not DLC listed.
 2 When high voltage (HV) is specified, IMSBT and ALBCS control options are limited to 6L and 8L lumen packages.
 3 IMSBTxL is field configurable via the LSI app that can be downloaded from your smartphone's native app store.
 4 Universal Voltage Only (120-277V). 20W Battery Backup only available 2L - 6L.
 5 For applications with surface conduit.

Mirada Small Wall Sconce Silicone (XWS SIL)

Type: _____

 Have questions? Call us at (800) 436-7800

PERFORMANCE

[Back to Quick Links](#)

Delivered Lumens ¹												
Lumen Package	Distribution	CRI	3000K CCT			4000K CCT			5000K CCT			Wattage
			Delivered Lumens	Efficacy	Bug Rating	Delivered Lumens	Efficacy	Bug Rating	Delivered Lumens	Efficacy	Bug Rating	
2L	2	70	1,851	142	B1-U0-G1	1,974	152	B1-U0-G1	1,976	152	B1-U0-G1	13
	3		1,930	148	B1-U0-G1	2,058	158	B1-U0-G1	2,060	158	B1-U0-G1	
	FT		1,889	145	B1-U0-G1	2,015	155	B1-U0-G1	2,017	155	B1-U0-G1	
3L	2	70	2,765	146	B1-U0-G1	2,950	155	B1-U0-G1	2,953	155	B1-U0-G1	19
	3		2,884	152	B1-U0-G1	3,077	162	B1-U0-G1	3,079	162	B1-U0-G1	
	FT		2,822	149	B1-U0-G1	3,010	158	B1-U0-G1	3,012	159	B1-U0-G1	
5L	2	70	4,655	133	B2-U0-G1	4,965	142	B2-U0-G1	4,970	142	B2-U0-G1	35
	3		4,855	139	B1-U0-G1	5,179	148	B1-U0-G1	5,184	148	B1-U0-G1	
	FT		4,750	136	B1-U0-G2	5,067	145	B1-U0-G2	5,072	145	B1-U0-G2	
6L	2	70	5,578	130	B2-U0-G1	5,950	138	B2-U0-G2	5,956	139	B2-U0-G2	43
	3		5,819	135	B1-U0-G2	6,207	144	B1-U0-G2	6,214	145	B1-U0-G2	
	FT		5,693	132	B1-U0-G2	6,073	141	B1-U0-G2	6,079	141	B1-U0-G2	
8L	2	70	7,531	123	B2-U0-G2	8,034	132	B2-U0-G2	8,041	132	B2-U0-G2	61
	3		7,856	129	B2-U0-G2	8,380	137	B2-U0-G2	8,388	138	B2-U0-G2	
	FT		7,687	126	B2-U0-G2	8,199	134	B2-U0-G2	8,207	135	B2-U0-G2	

Electrical Data - Current Draw AMPS ²						
Lumen Package	120V	208V	240V	277V	347V	480V
2L	0.11	0.06	0.05	0.05	0.04	0.03
3L	0.16	0.09	0.08	0.07	0.05	0.04
5L	0.29	0.17	0.15	0.13	0.10	0.07
6L	0.36	0.21	0.18	0.16	0.12	0.09
8L	0.51	0.29	0.25	0.22	0.18	0.13

Recommended Lumen Maintenance - XWS ³					
Ambient Temperature C°	Initial ⁴	25K hrs. ⁴	50K hrs. ⁴	75K hrs. ⁵	100K hrs. ⁵
25	100%	95%	90%	85%	80%
40	100%	91%	82%	73%	65%

1 LEDs are frequently updated therefore values are nominal

2 Electrical data at 25C (77F). Actual wattage may differ by +/-10%.

3 Lumen maintenance values at 25°C are calculated per TM-21 based on LM-80 data and in-situ luminaire testing.

4 In accordance with IESNA TM-21-11, Projected Values represent interpolated value based on time durations that are within six times (6X) the IESNA LM-80-08 total test duration (in hours) for the device under testing (DUT) i.e. the packaged LED chip).

5 In accordance with IESNA TM-21-11, Calculated Values represent time durations that exceed six times NA LM-80-08 total test duration (in hours) for the device under testing (DUT) i.e. the packaged LED chip).

Mirada Small Wall Sconce Silicone (XWS SIL)

Type : _____

 Have questions? Call us at (800) 436-7800

PHOTOMETRICS

[Back to Quick Links](#)

Luminaire photometry has been conducted by a NVLAP accredited testing laboratory in accordance with IESNA LM-79-08. As specified by IESNA LM-79-08 the entire luminaire is tested as the source resulting in a luminaire efficiency of 100%.

See the individual product page on <https://www.lsicorp.com/> for detailed photometric data.

XWS-LED-6L-SIL-2-40-70CRI

Luminaire Data	
Type 2 Distribution	
Description	4000 Kelvin, 70 CRI
Delivered Lumens	5,951
Watts	42.5
Efficacy	138
IES Type	Type II - Short
BUG Rating	B1-U0-G1

Zonal Lumen Summary		
Zone	Lumens	% Luminaire
Low (0-30°)	834	20%
Medium (30-60°)	3,379	50%
High (60-80°)	1,647	28%
Very High (80-90°)	91	1%
Uplight (90-180°)	0	0%
Total Flux	5,951	100%

ISO Footcandle

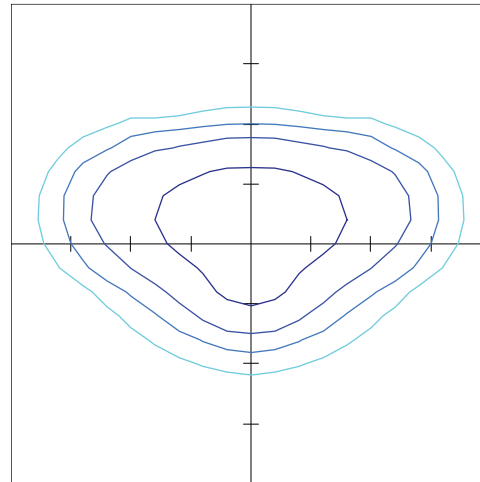

10' Mounting Height / 10' Grid Spacing
 5 FC 2 FC 1 FC 0.5 FC

Polar Curve

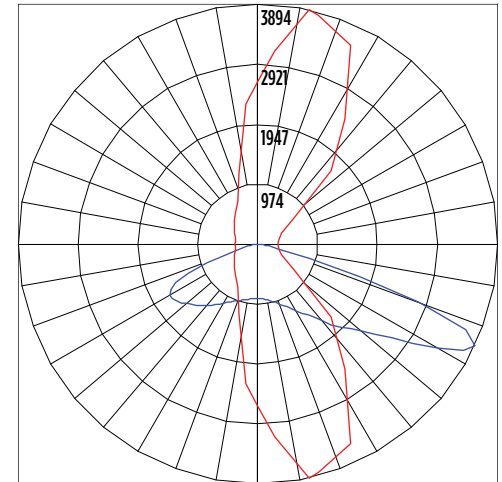

Vertical Plane Horizontal Cone

XWS-LED-6L-SIL-3-40-70CRI

Luminaire Data	
Type 3 Distribution	
Description	4000 Kelvin, 70 CRI
Delivered Lumens	6,208
Watts	42.5
Efficacy	146
IES Type	Type III - Medium
BUG Rating	B1-U0-G2

Zonal Lumen Summary		
Zone	Lumens	% Luminaire
Low (0-30°)	582	9%
Medium (30-60°)	2,997	48%
High (60-80°)	2,506	40%
Very High (80-90°)	124	2%
Uplight (90-180°)	0	0%
Total Flux	6,208	100%

ISO Footcandle

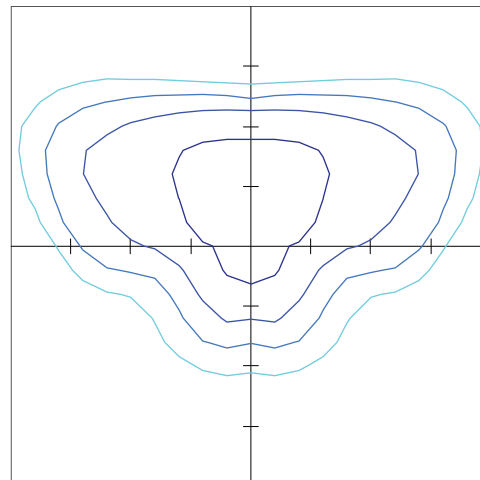

10' Mounting Height / 10' Grid Spacing
 5 FC 2 FC 1 FC 0.5 FC

Polar Curve

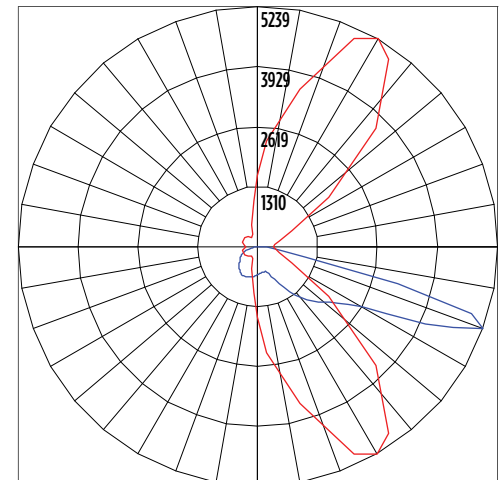

Vertical Plane Horizontal Cone

Mirada Small Wall Sconce Silicone (XWS SIL)

Type : _____

 **Have questions?** Call us at (800) 436-7800

PHOTOMETRICS

[Back to Quick Links](#)

XWS-LED-6L-SIL-FT-40-70CRI

Luminaire Data	
Type FT Distribution	
Description	4000 Kelvin, 70 CRI
Delivered Lumens	6,073
Watts	42.5
Efficacy	143
IES Type	Type IV - Short
BUG Rating	B1-U0-G2

Zonal Lumen Summary		
Zone	Lumens	% Luminaire
Low (0-30°)	708.3	12%
Medium (30-60°)	2,715.5	45%
High (60-80°)	2,475.4	41%
Very High (80-90°)	173.6	3%
Uplight (90-180°)	0	0%
Total Flux	6,073	100%

ISO Footcandle

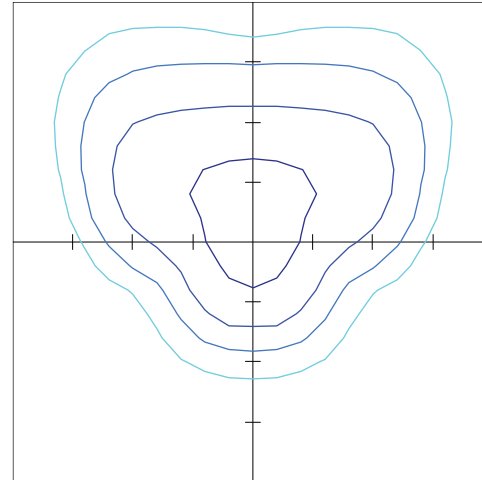

10' Mounting Height / 10' Grid Spacing
 5 FC
 2 FC
 1 FC
 0.5 FC

Polar Curve

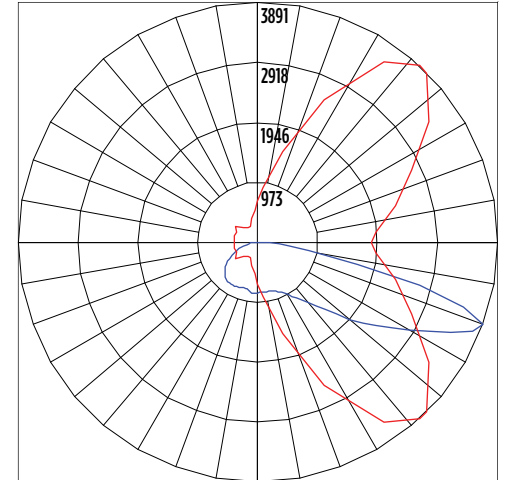

Vertical Plane
 Horizontal Cone

PRODUCT DIMENSIONS

[Back to Quick Links](#)

STANDARD HOUSING (XWS)

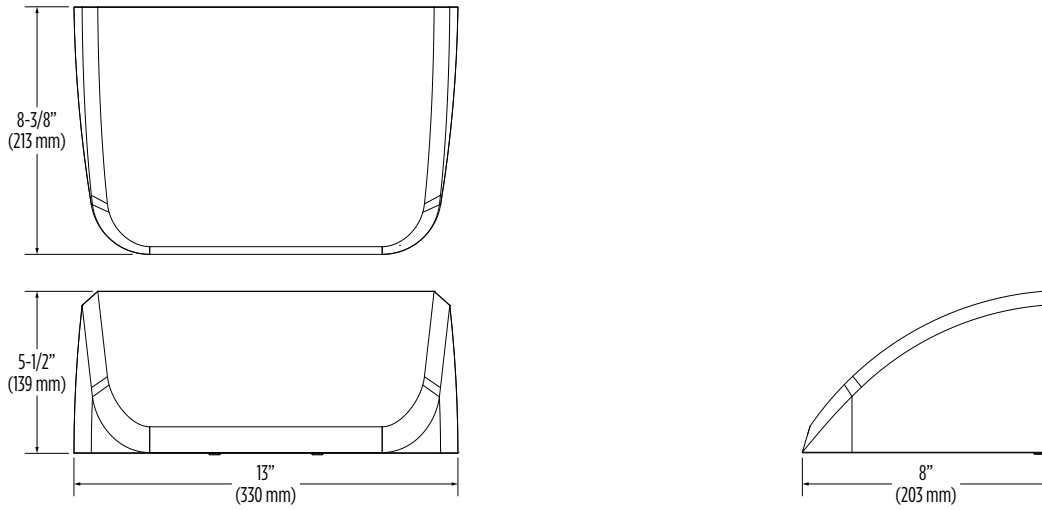

SCWB EXTENDED HOUSING (XWS 758274CLR)

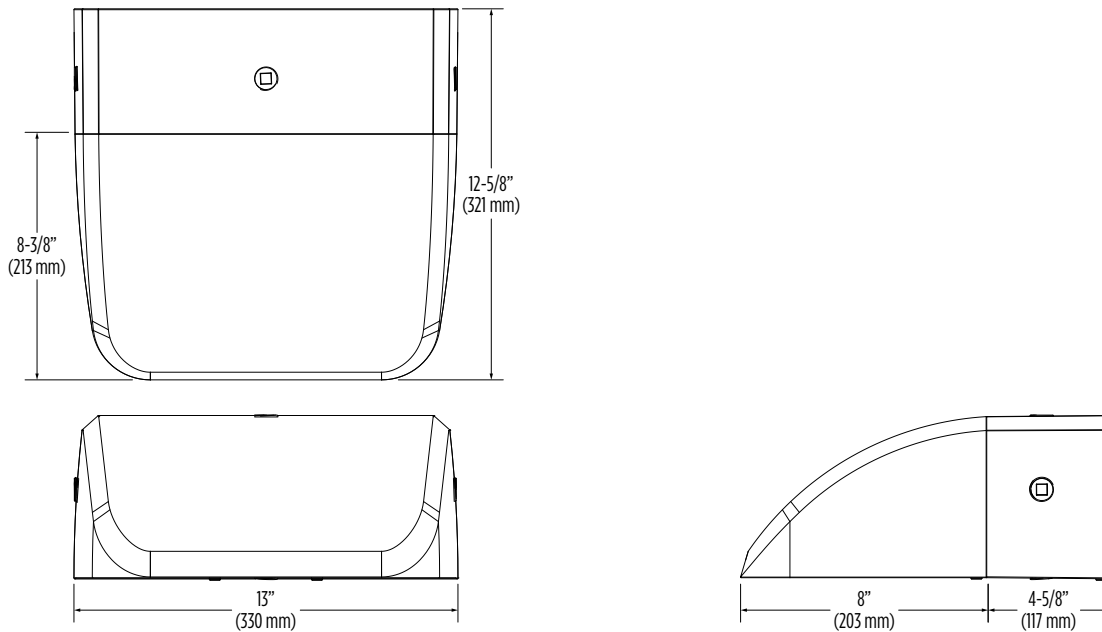

XWS SPACER PLATE/WIRING BOX (XWS 760159CLR)

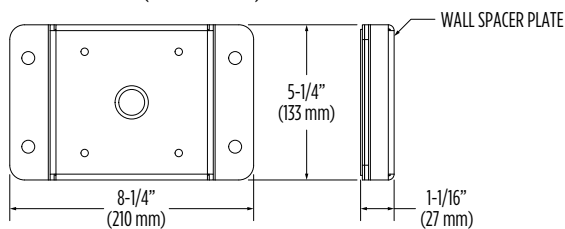

NOTE: Wall spacer plate allows the luminaire to float off the wall and provides space for securing wires (8.25" X 5.25" X 1.07").

CONTROLS

[Back to Quick Links](#)

Integral Bluetooth™ Motion and Photocell Sensor (IMSBTxL)

Slim low profile sensor provides multi-level control based on motion and/or daylight. Sensor controls 0-10 VDC LED drivers and is IP66 rated for cold and wet locations (-40°F to 167°F). Two unique PIR lenses are available and used based on fixture mounting height. All control parameters are adjustable via an iOS or Android App capable of storing and transmitting sensor profiles.

[Click here to learn more details about IMSBT](#)



LEVITON App



Apple



Android

AirLink Blue (ALBCSx)

Wireless Bluetooth Mesh Outdoor Lighting Control System that provides energy savings, code compliance and enhanced safety/security for parking lots and parking garages. Three key components; Bluetooth wireless radio/sensor controller, Time Keeper and an iOS App. Capable of grouping multiple fixtures and sensors as well as scheduling time-based events by zone. Radio/Sensor Controller is factory integrated into Area/Site, Wall Mounted, Parking Garage and Canopy luminaires.

[Click here to learn more details about AirLink Blue](#)



AirLink Blue App



Apple

Sensor Sequence of Operations

Standard Programming	On Event	Off Event	On Light Level	Dim Light Level	Daylight Harvesting	Delay To Off	Sensitivity
IMSBTxL	Motion	No Motion	100%	N/A	On; Auto Calibration	20 minutes	High

Operation	Description
On Event	Trigger that activates lights to turn on; either automatic via motion detected or manually activated via push of button.
Off Event	Trigger that activates lights to turn off; either automatic via no motion detected or manually activated via push of button.
On Light Level	The light level that the fixtures will turn on to when ON EVENT occurs.
Dim Light Level	The light level that the fixtures will dim down to when no motion is detected.
Delay to Dim	The amount of time after which no motion is detected that the fixtures will be triggered to dim down. This sequence is optional, and sensor can be programmed to only trigger the fixture to turn off by entering 100% in this field.
Delay to Off	The amount of time after which no motion is detected that the fixtures will be triggered to turn off. If delay to dim is part of the programmed functionality, this is the amount of time after which no motion is detected after the fixture have already dimmed down.
Sensitivity	The sensitivity can be set to high, medium, low, or auto where applicable. High will detect smaller, simple motions. Low will only detect larger more complex motions. Auto temperature calibration adjusts the PIR sensitivity as ambient temperature rises to increase detection of heat movement through the field of view.