

Project: SMART – Yard Expansion

Date: June 28, 2024

To: Interested Bidders

Prepared by: Burke Wardle, AIA

This Addendum modifies the Project Manual, Specifications, and Drawings as follows:

1. General Information

- 1.1. Any pre-bid questions that have not been addressed in this addendum will be answered in following addendums.

2. Changes to the Project Manual

- 2.1. Section 00 0110 Table of Content
 - 2.1.1. (Reissued) Added sections for Door Hardware
- 2.2. Section 07 4113 Metal Roof Panels
- 2.3. (Reissued) Section 2.04. Removed reference to soffit panels.
- 2.4. Section 08 3323 Overhead Coiling Doors
 - 2.4.1. (Reissued) Section 1.06.A. Revised warranty info as 2 year manufacturer warranty.
 - 2.4.2. (Reissued) Section 2.02.A.3. Revised to clarify aluminum slat gauge. Revised to remove alternate 1.
- 2.5. Section 08 7100 Door Hardware
 - 2.5.1. (Added) New section for door hardware.
- 2.6. Section 08 7110 Door Hardware Schedule
 - 2.6.1. (Added) New section for door hardware schedule.

3. Changes to the Drawings

- 3.1. Sheet C200
 - 3.1.1. (Added) – Added sheet for wash equipment.
- 3.2. Sheet P600
 - 3.2.1. (Reissued) – Updated trench drain to Class D rated with ductile iron grate.

4. Substitution Approvals

- 4.1. Specification Section 22 4000 Plumbing Fixtures
 - 4.1.1. Approved Trench Drain Substitution for Dura Trench, 05C24DG & DTPF4-HDBP08ZSA, see attached.
- 4.2. Luminaire Schedule Type S1, S2, W1.
 - 4.2.1. Approved, see attached.

5. Pre-Bid Questions

- 5.1. Q: Please provide subsurface or geologic investigation information per Special Provision 00120.25.
 - 5.1.1. A: See attached Geotech report.
- 5.2. Q: Spec Section 07 4113 includes metal soffit panels, however the reflected ceiling plan and details do not show soffit panels. Please clarify.
 - 5.2.1. A: Metal soffit panels not applicable, see attached updates in specification section.
- 5.3. Q: Foundation Plan S100 includes callout 5/S504 at the retaining wall. There is no detail 5 on S504. Please confirm this is to be 6/S504.
 - 5.3.1. A: Confirmed – 5/S504 that is cut on S100 should be 6/S504.
- 5.4. Q: Spec Section 11 1126 paragraph 2.01.F.1.b. "Model" says Three Supra washers. Please confirm one (1) Three-Brush Supra washers is requested.
 - 5.4.1. A: Confirmed, one (1) Three-Brush Supra Wash.
- 5.5. Q: No hardware groups are listed on A641 and no door hardware spec section is in current spec book. Please provide information on desired hardware.
 - 5.5.1. A: See attached hardware sections.
- 5.6. Q: Please review attached RFI from Overhead Innovations regarding warranty for overhead coiling doors.
 - 5.6.1. A: See attached overhead door updates in specification section.

-----End of Addenda-----

6. Attachments

- 6.1. 00 0110 - Table of Contents
- 6.2. 07 4113 - Metal Roof Panels
- 6.3. 08 3323 - Overhead Coiling Doors
- 6.4. 08 7100 - Door Hardware
- 6.5. 08 7110 - Door Hardware Schedule
- 6.6. Sheet C200
- 6.7. Sheet P600

**SECTION 00 0110
TABLE OF CONTENTS**

PROCUREMENT AND CONTRACTING REQUIREMENTS

1.01 DIVISION 00 -- PROCUREMENT AND CONTRACTING REQUIREMENTS

- A. 00 0110 - Table of Contents
- B. 00 0115 – List of Drawing Sheets

SPECIFICATIONS

2.01 DIVISION 01 -- GENERAL REQUIREMENTS

- A. 01 1000 - Summary
- B. 01 5339 - Temporary Plant Protection
- C. 01 2000 - Price and Payment Procedures
- D. 01 2500 - Substitution Procedures
- E. 01 3000 - Administrative Requirements
- F. 01 3216 - Construction Progress Schedule
- G. 01 4000 - Quality Requirements
- H. 01 5000 - Temporary Facilities and Controls
- I. 01 5100 - Temporary Utilities
- J. 01 5639 - Temporary Plant Protection
- K. 01 5713 - Erosion and Sediment Control
- L. 01 6000 - Product Requirements
- M. 01 6023 - Substitution Request Form
- N. 01 6116 - Volatile Organic Compound (VOC) Content Restrictions
- O. 01 7000 - Execution and Closeout Requirements
- P. 01 7419 - Construction Waste Management and Disposal
- Q. 01 7800 - Closeout Submittals

2.02 DIVISION 02 -- EXISTING CONDITIONS

- A. 02 4100 - Demolition

2.03 DIVISION 03 -- CONCRETE

- A. 03 1000 - Concrete Forming and Accessories
- B. 03 2000 - Concrete Reinforcing
- C. 03 3000 - Cast-in-Place Concrete
- D. 03 3511 - Concrete Floor Finishes

2.04 DIVISION 04 -- MASONRY

- A. 04 2000 - Unit Masonry

2.05 DIVISION 05 -- METALS

- A. 05 1200 - Structural Steel Framing
- B. 05 3100 - Steel Decking
- C. 05 5000 - Metal Fabrications

2.06 DIVISION 06 -- WOOD, PLASTICS, AND COMPOSITES

2.07 DIVISION 07 -- THERMAL AND MOISTURE PROTECTION

- A. 07 1400 - Fluid-Applied Waterproofing
- B. 07 4113 - Metal Roof Panels
- C. 07 6200 - Sheet Metal Flashing and Trim
- D. 07 7273 – Fall Arrest Roof Anchors
- E. 07 9200 - Joint Sealants

2.08 DIVISION 08 -- OPENINGS

- A. 08 1113 - Hollow Metal Doors and Frames
- B. 08 3323 - Overhead Coiling Doors
- C. 08 7100 - Door Hardware
- D. 08 7110 – Door Hardware Schedule

2.09 DIVISION 09 -- FINISHES

- A. 09 9600 - High-Performance Coatings

2.10 DIVISION 10 -- SPECIALTIES

2.11 DIVISION 11 -- EQUIPMENT

- A. 11 1126 - Vehicle Wash Equipment

2.12 DIVISION 12 -- FURNISHINGS

2.13 DIVISION 13 -- SPECIAL CONSTRUCTION

2.14 DIVISION 14 -- CONVEYING EQUIPMENT

2.15 DIVISION 21 -- FIRE SUPPRESSION

2.16 DIVISION 22 -- PLUMBING

- A. 22 0519 - Meters And Gauges For Plumbing Piping
- B. 22 0523 - General-Duty Valves For Plumbing Piping
- C. 22 0529 - Hangers And Supports For Plumbing Piping And Equipment
- D. 22 0548 - Vibration And Seismic Controls For Plumbing Piping And Equipment
- E. 22 0553 - Identification For Plumbing Piping And Equipment
- F. 22 0719 - Plumbing Piping Insulation
- G. 22 1005 - Plumbing Piping
- H. 22 1006 - Plumbing Piping Specialties
- I. 22 1500 - General-Service Compressed-Air Systems
- J. 22 4000 - Plumbing Fixtures

2.17 DIVISION 23 -- HEATING, VENTILATING, AND AIR-CONDITIONING (HVAC)

- A. 23 0529 - Hangers and Supports for HVAC Piping and Equipment
- B. 23 0553 - Identification for HVAC Piping and Equipment
- C. 23 3100 - HVAC Ducts and Casings
- D. 23 3416 - Centrifugal HVAC Fans
- E. 23 8239 - Cabinet Unit Heaters

2.18 DIVISION 25 -- INTEGRATED AUTOMATION

2.19 DIVISION 26 -- ELECTRICAL

- A. 26 0500 - Common Work Results For Electrical
- B. 26 0505 - Selective Demolition For Electrical
- C. 26 0519 - Low-Voltage Electrical Power Conductors And Cables

- D. 26 0526 - Grounding And Bonding For Electrical Systems
- E. 26 0529 - Hangers And Supports For Electrical Systems
- F. 26 0533.13 - Conduit For Electrical Systems
- G. 26 0533.16 - Boxes For Electrical Systems
- H. 26 0553 - Identification For Electrical Systems
- I. 26 0573 - Power System Studies
- J. 26 2100 - Low-Voltage Electrical Service Entrance
- K. 26 2413 - Switchboards
- L. 26 2416 - Panelboards
- M. 26 2726 - Wiring Devices
- N. 26 4300 - Surge Protective Devices
- O. 26 5100 - Interior Lighting
- P. 26 5600 - Exterior Lighting

2.20 DIVISION 27 -- COMMUNICATIONS

- A. 27 0000 - General Requirements For Communications Systems
- B. 27 0526 - Grounding And Bonding For Communication Systems
- C. 27 0528 - Pathways For Communications Systems
- D. 27 0543 - Underground Ducts And Raceways For Communication Systems
- E. 27 0544 - Sleeves And Sleeve Seals For Communications Pathways And Cabling
- F. 27 0553 - Identification For Communications Systems
- G. 27 1000 - Structured Cabling

2.21 DIVISION 28 -- ELECTRONIC SAFETY AND SECURITY

2.22 DIVISION 31 -- EARTHWORK

- A. 31 0519 - Geotextile Fabric
- B. 31 1100 - Clearing Grubbing and Stripping
- C. 31 2300 - Excavating Backfilling and Compacting
- D. 31 2333 - Trench Excavation and Backfill for Utilities

2.23 DIVISION 32 -- EXTERIOR IMPROVEMENTS

- A. 32 1133 - Aggregate Base
- B. 32 1313 - Portland Cement Concrete Pavement
- C. 32 1613 - Concrete Curbs Gutters Driveways Islands and Sidewalks
- D. 32 1723 - Pavement Markings
- E. 32 3113 - Chain Link Fences and Gates
- F. 32 3129 - Wood Fencing
- G. 32 3133 - Gate Operators
- H. 32 3200 - Retaining Walls
- I. 32 8423 - Landscape Irrigation System
- J. 32 9113 - Soil Preparation
- K. 32 9200 - Turf and Grasses
- L. 32 9300 - Plants
- M. 32 9445 - Landscape Maintenance

2.24 DIVISION 33 -- UTILITIES

- A. 33 0513 - Adjustment of Incidental Structures

2.25 DIVISION 34 -- TRANSPORTATION

2.26 DIVISION 40 -- PROCESS INTEGRATION

2.27 DIVISION 46 -- WATER AND WASTEWATER EQUIPMENT

END OF SECTION

**SECTION 07 4113
METAL ROOF PANELS**

PART 1 GENERAL

1.01 SECTION INCLUDES

- A. Insulated metal roof panel system of preformed steel panels.
- B. Metal roof panel system of preformed steel panels.
- C. Metal panels for soffits with related flashings and components.
- D. Snow and ice retention system.

1.02 RELATED REQUIREMENTS

- A. Section 05 1200 - Structural Steel Framing: Roof framing and purlins.
- B. Section 07 2100 - Thermal Insulation: Rigid roof insulation.

1.03 REFERENCE STANDARDS

- A. AAMA 2605 - Voluntary Specification, Performance Requirements and Test Procedures for Superior Performing Organic Coatings on Aluminum Extrusions and Panels (with Coil Coating Appendix); 2020, with Errata (2022).
- B. ASCE 7 - Minimum Design Loads and Associated Criteria for Buildings and Other Structures; Most Recent Edition Cited by Referring Code or Reference Standard.
- C. ASTM A792/A792M - Standard Specification for Steel Sheet, 55% Aluminum-Zinc Alloy-Coated by the Hot-Dip Process; 2010 (Reapproved 2015).
- D. ASTM D1970/D1970M - Standard Specification for Self-Adhering Polymer Modified Bituminous Sheet Materials Used as Steep Roofing Underlayment for Ice Dam Protection; 2019.
- E. ASTM E96/E96M - Standard Test Methods for Water Vapor Transmission of Materials; 2016.
- F. ASTM E1592 - Standard Test Method for Structural Performance of Sheet Metal Roof and Siding Systems by Uniform Static Air Pressure Difference; 2005 (Reapproved 2017).
- G. ASTM E1646 - Standard Test Method for Water Penetration of Exterior Metal Roof Panel Systems by Uniform Static Air Pressure Difference; 1995 (Reapproved 2018).
- H. ASTM E1680 - Standard Test Method for Rate of Air Leakage through Exterior Metal Roof Panel Systems; 2016 (Reapproved 2022).
- I. UL 580 - Standard for Tests for Uplift Resistance of Roof Assemblies; Current Edition, Including All Revisions.

1.04 SUBMITTALS

- A. See Section 01 3000 - Administrative Requirements for submittal procedures.
- B. Product Data: Manufacturer's data sheets on each product to be used, including:
 - 1. Storage and handling requirements and recommendations.
 - 2. Installation methods.
 - 3. Specimen warranty.
- C. Shop Drawings: Include layouts of roof panels, details of edge and penetration conditions, spacing and type of connections, flashings, underlayments, and special conditions.
 - 1. Show work to be field-fabricated or field-assembled.
 - 2. Include structural analysis signed and sealed by qualified structural engineer, indicating conformance of roofing system to specified loading conditions, with attachment schedule specific to project.
- D. Verification Samples: For each roofing system specified, submit samples of minimum size 12 inches (305 mm) square, representing actual roofing metal, thickness, profile, color, and texture.
 - 1. Include typical panel joint in sample.
 - 2. Include typical fastening detail.

- E. Test Reports: Indicate compliance of metal roofing system to specified requirements.
- F. Warranty: Submit specified manufacturer's warranty and ensure that forms have been completed in Owner's name and are registered with manufacturer.

1.05 QUALITY ASSURANCE

- A. Manufacturer Qualifications: Company specializing in manufacturing products specified in this section and with at least three years of documented experience.
- B. Installer Qualifications: Company specializing in performing work of the type specified and with at least three years of documented experience.

1.06 DELIVERY, STORAGE, AND HANDLING

- A. Provide strippable plastic protection on prefinished roofing panels for removal after installation.
- B. Store roofing panels on project site as recommended by manufacturer to minimize damage to panels prior to installation.

1.07 WARRANTY

- A. See Section 01 7800 - Closeout Submittals for additional warranty requirements.
- B. Finish Warranty: Provide 5-year manufacturer warranty against excessive degradation of exterior finish. Include provision for replacement of units with excessive fading, chalking, or flaking. Complete forms in Owner's name and register with warrantor.
- C. Special Warranty: Provide 2-year warranty for weathertightness of roofing system, including agreement to repair or replace metal roof panels that fail to keep out water commencing on the Date of Substantial Completion. Complete forms in Owner's name and register with warrantor.

PART 2 PRODUCTS

2.01 MANUFACTURERS

- A. Manufacturer and installer of Metal Roof Panels specified in Section 07 4113 must be the same as the manufacturer and installer of Metal Wall Panels specified in Section 07 4213.
- B. Metal Roof Panels:
 - 1. Basis of Design: Taylor Metal Products; Slim-Lock: taylormetal.com
 - 2. AEP SPAN; www.aep-span.com.
 - 3. Architectural Metal Solutions, AMS Armor Lock: www.ams.wa.com
 - 4. Metal Sales Manufacturing Corporation: www.metalsales.us.com.
 - 5. Substitutions: See Section 01 6000 - Product Requirements.

2.02 PERFORMANCE REQUIREMENTS

- A. Metal Roof Panels: Provide complete roofing assemblies, including roof panels, clips, bearing plates, fasteners, connectors, and miscellaneous accessories, tested for compliance with the following minimum standards:
 - 1. Structural Design Criteria: Provide panel assemblies designed to safely support design loads at support spacing indicated, with deflection not to exceed L/180 of span length(L) when tested in accordance with ASTM E1592.
 - a. Dead Loads: Weight of roofing system, and roof-mounted components where indicated.
 - b. Live Loads: As required by ASCE 7.
 - 2. Overall: Complete weathertight system tested and approved in accordance with ASTM E1592.
 - 3. Wind Uplift: Class 90 wind uplift resistance of UL 580.
 - 4. Air Infiltration: Maximum 0.06 cfm/sq ft (1.1 cu m/hr/sq m) at air pressure differential of 6.24 lbf/sq ft (300 Pa), when tested according to ASTM E1680.
 - 5. Water Penetration: No water penetration when tested in accordance with procedures and recommended test pressures of ASTM E1646; perform test immediately following air infiltration test.

6. Thermal Movement: Design system to accommodate without deformation anticipated thermal movement over ambient temperature range of 100 degrees F (56 degrees C).

2.03 METAL ROOF PANELS

- A. Metal Roof Panels: Provide complete engineered system complying with specified requirements and capable of remaining weathertight while withstanding anticipated movement of substrate and thermally induced movement of roofing system.
- B. Metal Panels: Factory-formed panels with factory-applied finish.
 1. Steel Panels:
 - a. Aluminum-zinc alloy-coated steel complying with ASTM A792/A792M; minimum AZ50 (AZM150) coating.
 - b. Steel Thickness: Minimum 22 gauge, 22 inch (___ mm).
 2. Profile: Standing seam, with minimum 1-1/2-inch (38 mm) seam height; concealed fastener system for field seaming with special tool.
 3. Texture: Smooth, with intermediate ribs for added stiffness.
 4. Length: Full length of roof slope, without lapped horizontal joints.
 5. Width: Maximum panel coverage of 18 inches (457 mm).

2.04 NOT USED

2.05 ATTACHMENT SYSTEM

- A. Concealed System: Provide manufacturer's standard stainless steel concealed anchor clips designed for specific roofing system and engineered to meet performance requirements, including anticipated thermal movement.
 1. Anchor clips shall be tested to establish that the clips will have 75% of the material thickness remaining after 100,000 cycles of the full range of motion.
- B. Bearing Plates: Approximately 4 inch by 6 inch, Zinalume coated steel bearing plates at each clip for installation over compressible substrates.
- C. Fasteners: Self-drilling galvanized or stainless steel screws engineered to meet performance requirements.

2.06 THERMAL INSULATION

- A. Rigid insulation board as specified in section 07 2100 Thermal Insulation.

2.07 FINISHES

- A. Fluoropolymer Coil Coating System: Manufacturer's standard multi-coat aluminum coil coating system complying with AAMA 2605, including at least 70 percent polyvinylidene fluoride (PVDF) resin, and at least 80 percent of coil coated aluminum surfaces having minimum total dry film thickness (DFT) of 0.9 mil, 0.0009 inch (0.023 mm); color and gloss to match sample.
- B. Colors: As shown on Drawings.
- C. Underside finish: Manufacturer's standard off-white enamel.

2.08 ACCESSORIES

- A. Miscellaneous Sheet Metal Items: Provide flashings, gutters, downspouts, trim, moldings, closure strips, preformed crickets, caps, and equipment curbs of the same material, thickness, and finish as used for the roofing panels. Items completely concealed after installation may optionally be made of stainless steel.
- B. Rib and Ridge Closures: Provide prefabricated, close-fitting components of steel with corrosion resistant finish or combination steel and closed-cell foam.
- C. Sealants:
 1. Exposed Sealant: Elastomeric; silicone, polyurethane, or silyl-terminated polyether/polyurethane.
 2. Concealed Sealant: Non-curing butyl sealant or tape sealant.
- D. Underlayment: Self-adhering rubber-modified asphalt sheet complying with ASTM D1970/D1970M, with strippable release film and top surface of woven polypropylene sheet.

1. Sheet Thickness: 40 mil, 0.040 inch (1.02 mm) minimum total thickness.
 2. Water Vapor Permeance: 0.1 perm (5.72 ng/Pa s sq m), maximum, when tested in accordance with ASTM E96/E96M, Desiccant Method A.
 3. Products:
 - a. Henry Company; Blueskin PE200HT: www.henry.com.
 - b. Polyglass USA, Inc; Polystick MTS Self-Adhered High Temperature Roof Underlayment: www.polyglass.us.
 - c. Substitutions: See Section 01 6000 - Product Requirements.
- E. Vapor Retarder: Material approved by roof manufacturer; compatible with roofing and insulation materials.
1. Self-adhered SBS modified bitumen vapor retarder/air barrier/temporary roofing membrane, 31 mils thick, with tri-laminated woven polyethylene facer that can accept approved urethane adhesives for insulation attachment.
 - a. Sika SA 31 (Basis of Design) with primer recommended by manufacturer.
 - b. Substitutions: See Section 01 6000 - Product Requirements.
- F. Deck Sheathing:
1. Material: Glass-mat faced gypsum panels complying with ASTM C1177/C1177M.
 2. Thickness: 1/2 inch, fire-resistant.
 3. Products:
 - a. Georgia-Pacific; DensDeck: www.densdeck.com.
 - b. National Gypsum Company; DEXcell FA Glass Mat Roof Board: www.nationalgypsum.com.
 - c. USG Corporation; Securock Ultralight Glass-Mat Roof Board: www.usg.com.
 - d. Substitutions: See Section 01 6000 - Product Requirements.

PART 3 EXECUTION

3.01 EXAMINATION

- A. Do not begin installation of preformed metal roof panels until substrates have been properly prepared.
- B. If substrate preparation is the responsibility of another installer, notify Architect of unsatisfactory preparation before proceeding.

3.02 PREPARATION

- A. Coordinate roofing work with provisions for weather barrier, slip sheet, roof drainage, flashing, trim, penetrations, and other adjoining work to assure that the completed roof will be free of leaks.
- B. Remove protective film from surface of roof panels immediately prior to installation; strip film carefully to avoid damage to prefinished surfaces.
- C. Separate dissimilar metals by applying a bituminous coating, self-adhering rubberized asphalt sheet, or other permanent method approved by metal roof panel manufacturer.
- D. At locations where metal will be in contact with wood or other absorbent material subject to wetting, seal joints with sealing compound and apply one coat of heavy-bodied bituminous paint.

3.03 INSTALLATION

- A. Overall: Install roofing system in accordance with approved shop drawings and metal roof panel manufacturer's instructions and recommendations, as applicable to specific project conditions; securely anchor components of roofing system in place allowing for thermal and structural movement.
 1. Install roofing system with concealed clips and fasteners, except as otherwise recommended by manufacturer for specific circumstances.
 2. Minimize field cutting of panels. Where field cutting is required, use methods that will not distort panel profiles. Use of torches for field cutting is prohibited.

- B. Accessories: Install necessary components that are required for complete roofing assembly, including flashings, gutters, downspouts, trim, moldings, closure strips, preformed crickets, caps, equipment curbs, rib closures, ridge closures, and similar roof accessory items.
- C. If required by metal roof manufacturer or underlayment manufacturer, install slip sheet over weather barrier before installing metal roof panels.
- D. Roof Panels: Install metal roof panels in accordance with manufacturer's installation instructions, minimizing transverse joints except at junction with penetrations.

3.04 CLEANING

- A. At completion of each day's work, sweep panels, flashings and gutters clean. Do not allow fasteners, cuttings, filings or scraps to accumulate.
- B. Clean exposed sheet metal work at completion of installation. Remove grease and oil films, excess joint sealer, handling marks, and debris from installation, leaving the work clean and unmarked, free from dents, creases, waves, scratch marks, or other damage to the finish.

3.05 PROTECTION

- A. Do not permit storage of materials or roof traffic on installed roof panels. Provide temporary walkways or planks as necessary to avoid damage to completed work. Protect roofing until completion of project.
- B. Replace damaged roof panels or accessories before date of Substantial Completion. Panels or flashings that have severe paint and/or substrate damage shall be replaced as directed by the Architect's or Owner's representative.

END OF SECTION

**SECTION 08 3323
OVERHEAD COILING DOORS**

PART 1 GENERAL

1.01 SECTION INCLUDES

- A. Exterior coiling doors.
- B. Electric operators and control stations.
- C. Wiring from electric circuit disconnect to operators and control stations.

1.02 RELATED REQUIREMENTS

- A. Section 01 2300 - Alternates: Alternate for door material.
- B. Section 09 9600 - High Performance Coatings: Field paint finish.
- C. Division 26: Electrical connections.

1.03 REFERENCE STANDARDS

- A. ASTM A36/A36M - Standard Specification for Carbon Structural Steel; 2019.
- B. ASTM B221 - Standard Specification for Aluminum and Aluminum-Alloy Extruded Bars, Rods, Wire, Profiles, and Tubes; 2021.
- C. ITS (DIR) - Directory of Listed Products; current edition.
- D. NEMA 250 - Enclosures for Electrical Equipment (1000 Volts Maximum); 2020.
- E. NEMA ICS 2 - Industrial Control and Systems Controllers, Contactors and Overload Relays Rated 600 Volts; 2000, with Errata (2008).
- F. NEMA MG 1 - Motors and Generators; 2018.
- G. UL (DIR) - Online Certifications Directory; Current Edition.
- H. UL 325 - Standard for Door, Drapery, Gate, Louver, and Window Operators and Systems; Current Edition, Including All Revisions.

1.04 SUBMITTALS

- A. See Section 01 3000 - Administrative Requirements, for submittal procedures.
- B. Product Data: Provide general construction, electrical equipment, and component connections and details.
- C. Shop Drawings: Indicate pertinent dimensioning, anchorage methods, hardware locations, and installation details.
- D. Manufacturer's Installation Instructions: Indicate installation sequence and procedures, adjustment and alignment procedures.
- E. Manufacturer's qualification statement.
- F. Installer's qualification statement.
- G. Maintenance Data: Indicate lubrication requirements and frequency and periodic adjustments required.
- H. Executed warranties.
- I. Warranty Documentation: Submit manufacturer warranty and ensure that forms have been completed in Owner's name and registered with manufacturer.

1.05 QUALITY ASSURANCE

- A. Manufacturer Qualifications: Company specializing in manufacturing the products specified in this section with minimum three years of documented experience.
- B. Installer Qualifications: Company specializing in performing work of type specified and with at least three years documented experience.

- C. Products Requiring Electrical Connection: Listed and classified by ITS (DIR), UL (DIR), or testing firm acceptable to authorities having jurisdiction as suitable for purpose specified.

1.06 WARRANTY

- A. See Section 01 7800 - Closeout Submittals, for additional warranty requirements.
- B. Manufacturer Warranty: Provide 2 year manufacturer warranty for counterweights and tension springs. Complete forms in Owner's name and register with manufacturer.

PART 2 PRODUCTS

2.01 MANUFACTURERS

- A. Overhead Coiling Doors:
 - 1. Overhead Door Corporation: www.overhaddoor.com
 - 2. Cornell Iron Works, Inc: www.cornelliron.com/#sle.
 - 3. The Cookson Company: www.cooksondoor.com/#sle.
 - 4. Substitutions: See Section 01 6000 - Product Requirements.

2.02 COILING DOORS

- A. **Base Bid:** Exterior Coiling Doors: Aluminum slat curtain.
 - 1. Similar to Overhead Door Corporation "620 Series Stormtite Rolling Door"
 - 2. Capable of withstanding positive and negative wind loads of 20 psf (940 Pa) without undue deflection or damage to components.
 - 3. Single Thickness Slats:
 - a. Similar to Overhead Door Corporation "F265".
 - b. Front Slat: .040 inch (1mm) aluminum.
 - c. Slat Thickness: 5/8 inch.
 - d. Nominal Slat Size: 2 5/8 inches wide x required length.
 - e. Finish: Mill (clear anodized finish).
 - 4. Weatherseals: Vinyl bottom seal, exterior guide and internal hood seals. Interior guide seals. Lintel seals.
 - 5. Bottom Bar: Extruded aluminum
 - 6. Guides: Angles; galvanized steel. With PVC weather seals
 - a. Provide windlock bars to meet design windloads.
 - 7. Brackets: Galvanized steel to support the barrel, counterbalance, motor and hood.
 - 8. Counterbalance: Helical torsion springs housed in a steel pipe barrel. Counterbalance shall be housed in a steel tube or pipe barrel, supporting the curtain with deflection limited to 0.03 per foot of span. Counterbalance shall be adjustable by means of an adjusting tension wheel.
 - 9. Counterbalance: Helical torsion springs housed in a steel pipe barrel. Counterbalance shall be housed in a steel tube or pipe barrel, supporting the curtain with deflection limited to 0.03 per foot of span. Counterbalance shall be adjustable by means of an adjusting tension wheel.
 - 10. Hood: Aluminum hood with intermediate supports as required.
 - 11. Electric operation with manual hand chain back-up.
 - 12. Mounting: Surface mounted.

2.03 ELECTRIC OPERATION

- A. Operator, Controls, Actuators, and Safeties: Comply with UL 325; provide products listed by ITS (DIR), UL (DIR), or testing agency acceptable to authorities having jurisdiction.
 - 1. Provide interlock switches on motor operated units.
- B. Electric Operators:
 - 1. Mounting: Side mounted.
 - a. Contractor to verify required clearances and make alterations as necessary without any additional cost to Owner.
 - 2. Motor Enclosure:
 - a. Exterior Coiling Doors: NEMA MG 1, Type 4; totally enclosed fan cooled (TEFC).

3. Motor Rating: 1 HP (750 W); continuous duty.
 4. Motor Voltage: 120 volts, single phase, 60 Hz.
 5. Motor Controller: NEMA ICS 2, full voltage, reversing magnetic motor starter.
 6. Controller Enclosure: NEMA 250, Type 1.
 7. Opening Speed: 12 inches per second (300 mm/sec).
 8. Brake: Adjustable friction clutch type, activated by motor controller.
 9. Manual chain-drive back-up override in case of power failure.
 10. See Division 26 for electrical connections.
- C. Control Station: Provide standard three button, "Open-Close-Stop" momentary-contact control device for each operator complying with UL 325.
1. 24 volt circuit.
 2. Surface mounted, at inside and outside wall adjacent to each door.
 3. Entrapment Protection Devices: Provide sensing devices and safety mechanisms complying with UL 325.
 - a. Primary Device: Provide electric sensing edge, wireless sensing, NEMA 1 photo eye sensors, or NEMA 4X photo eye sensors as required with momentary-contact control device.
- D. Safety Edge: Located at bottom of coiling door, full width, electro-mechanical sensitized type, wired to stop and reverse door direction upon striking object, hollow neoprene covered.

PART 3 EXECUTION

3.01 EXAMINATION

- A. Verify that opening sizes, tolerances and conditions are acceptable.

3.02 INSTALLATION

- A. Install units in accordance with manufacturer's instructions.
- B. Use anchorage devices to securely fasten assembly to wall construction and building framing without distortion or stress.
- C. Securely and rigidly brace components suspended from structure. Secure guides to structural members only.
- D. Fit and align assembly including hardware; level and plumb, to provide smooth operation.
 1. Install doors free of warp, twist, and distortion.
- E. Coordinate installation of electrical service with Division 26.
- F. Complete wiring from disconnect to unit components.
- G. Protect contacting dissimilar metals against galvanic corrosion.

3.03 TOLERANCES

- A. Maintain dimensional tolerances and alignment with adjacent work.
- B. Maximum Variation From Plumb: 1/16 inch (1.6 mm).
- C. Maximum Variation From Level: 1/16 inch (1.6 mm).
- D. Longitudinal or Diagonal Warp: Plus or minus 1/8 inch per 10 feet (3.2 mm per 3 m) straight edge.

3.04 ADJUSTING

- A. Adjust operating assemblies for smooth and noiseless operation.

3.05 CLEANING

- A. Clean installed components.
- B. Remove labels and visible markings.

END OF SECTION

**SECTION 08 7100
DOOR HARDWARE**

PART 1 GENERAL

1.01 SECTION INCLUDES

- A. Hardware for hollow metal doors.
- B. Electrically operated and controlled hardware.
- C. Thresholds.
- D. Weatherstripping and gasketing.
- E. Gate locks.

1.02 RELATED REQUIREMENTS

- A. Section 07 9200 - Joint Sealants: Sealants for setting exterior door thresholds.
- B. Section 08 1113 - Hollow Metal Doors and Frames.
- C. Section 08 7110 - Door Hardware Schedule: Schedule of door hardware sets.
- D. Section 28 1000 - Access Control: Electronic access control devices.

1.03 REFERENCE STANDARDS

- A. ADA Standards - Americans with Disabilities Act (ADA) Standards for Accessible Design; 2010.
- B. BHMA A156.1 - Standard for Butts and Hinges; 2021.
- C. BHMA A156.4 - Door Closers and Pivots; 2024.
- D. BHMA A156.6 - Standard for Architectural Door Trim; 2021.
- E. BHMA A156.8 - Door Controls - Overhead Stops and Holders; 2021.
- F. BHMA A156.21 - Thresholds; 2019.
- G. BHMA A156.22 - Standard for Gasketing; 2021.
- H. BHMA A156.23 - Electromagnetic Locks; 2017.
- I. DHI (H&S) - Sequence and Format for the Hardware Schedule; 2019.
- J. DHI (LOCS) - Recommended Locations for Architectural Hardware for Standard Steel Doors and Frames; 2004.
- K. ICC A117.1 - Accessible and Usable Buildings and Facilities; 2017.
- L. NFPA 70 - National Electrical Code; Most Recent Edition Adopted by Authority Having Jurisdiction, Including All Applicable Amendments and Supplements.
- M. OSSC - Oregon Structural Specialty Code; latest edition
- N. UL (DIR) - Online Certifications Directory; Current Edition.

1.04 ADMINISTRATIVE REQUIREMENTS

- A. This specification is intended as a guideline for quality and operation and is not to be construed as a complete list. It is the specific responsibility of the hardware supplier to furnish complete hardware for all openings that is functional, meets the Owner's intended use, and in full compliance with all State and Local Building Codes, Fire Codes, disability and accessibility codes. Any supplier bidding on this section of the work shall notify the Architect prior to bidding, in accordance with Division 0 requirements of discrepancies or will be assumed to have included correct material to make this compliance
- B. To provide a higher level of coordination the following building materials must be provided by the same sub-contractor.
 - 1. 08 1113 - Hollow Metal Doors and Frames
 - 2. 08 1416 - Flush Wood Doors
 - 3. 08 7100 - Door Hardware

- C. Coordinate the manufacture, fabrication, and installation of products that door hardware is installed on.
- D. Sequence installation to ensure utility connections are achieved in an orderly and expeditious manner.
- E. Furnish templates for door and frame preparation to manufacturers and fabricators of products requiring internal reinforcement for door hardware.
- F. Keying Requirements Meeting:
 - 1. Attendance Required:
 - a. Contractor.
 - b. Owner.
 - c. Architect.
 - d. Owner's Security Consultant.
 - 2. Agenda:
 - a. Establish keying requirements.
 - b. Verify locksets and locking hardware are functionally correct for project requirements.
 - c. Verify that keying and programming complies with project requirements.
 - d. Establish keying submittal schedule and update requirements.
 - 3. Incorporate "Keying Requirements Meeting" decisions into keying submittal upon review of door hardware keying system including, but not limited to, the following:
 - a. Access control requirements.
 - 4. Record minutes and distribute copies within two days after meeting to participants, with copies to Architect, Owner, participants, and those affected by decisions made.
 - 5. Deliver established keying requirements to manufacturers.

1.05 SUBMITTALS

- A. See Section 01 3000 - Administrative Requirements for submittal procedures.
- B. Product Data: Manufacturer's catalog literature for each type of hardware, marked to clearly show products to be furnished for this project, and includes construction details, material descriptions, finishes, and dimensions and profiles of individual components.
- C. Shop Drawings - Door Hardware Schedule: Submit detailed listing that includes each item of hardware to be installed on each door. Use door numbering scheme as included in Contract Documents.
 - 1. Comply with DHI (H&S) using door numbers and hardware set numbers as indicated in construction documents.
 - 2. List groups and suffixes in proper sequence.
 - 3. Door numbers must be in numerical sequence.
 - 4. Provide complete description for each door listed.
 - 5. Provide manufacturer's and product names, and catalog numbers; include functions, types, styles, sizes and finishes of each item.
 - a. Include clean and clear digital catalog cut sheets with products to be used on the project properly highlighted.
 - 6. Include account of abbreviations and symbols used in schedule.
- D. Shop Drawings - Electrified Door Hardware: Submit diagrams for power, signal, and control wiring for electrified door hardware that include details of interface with building safety and security systems. Provide elevations and diagrams for each electrified door opening as follows:
 - 1. Prepared by or under supervision of Architectural Hardware Consultant (AHC) and Electrified Hardware Consultant (EHC).
 - 2. Elevations: Submit front and back elevations of each door opening showing electrified devices with connections installed and an operations narrative describing how opening operates from either side at any given time.
 - 3. Diagrams: Submit point-to-point wiring diagram that shows each device in door opening system with related colored wire connections to each device.

- E. Manufacturer's Installation Instructions: Indicate special procedures and perimeter conditions requiring special attention.
- F. Maintenance Data: Include data on operating hardware, lubrication requirements, and inspection procedures related to preventative maintenance.
- G. Keying Schedule:
 - 1. Submit one digital copies of Keying Schedule in compliance with requirements established during Keying Requirements Meeting unless otherwise indicated.
- H. Warranty: Submit manufacturer's warranty and ensure that forms have been completed in Owner's name and registered with manufacturer.
- I. Project Record Documents: Record actual locations of concealed equipment, services, and conduit.
- J. Operations & Maintenance Data: Hardware supplier will reissue a complete schedule when changes occur during the project, and will supply the contractor with a digital copy of the final hardware schedule for the O & M Manual.
- K. Maintenance Materials and Tools: Furnish the following for Owner's use in maintenance of project.
 - 1. See Section 01 6000 - Product Requirements, for additional provisions.
 - 2. Lock Cylinders: Ten for each master keyed group.
 - 3. Tools: One set of each special wrench or tool applicable for each different or special hardware component, whether supplied by hardware component manufacturer or not.

1.06 QUALITY ASSURANCE

- A. Manufacturer Qualifications: Company specializing in manufacturing products specified in this section with minimum three years of documented experience.
- B. Installer Qualifications: Company specializing in performing work of the type specified for commercial door hardware with at least three years of documented experience.
- C. Hardware Supplier Qualifications: Company specializing in supplying the type of products specified in this section with at least three years documented experience, and with certified Architectural Hardware Consultant (AHC) and Electrified Hardware Consultant (EHC) to assist in work of this section.
- D. Prior to final project acceptance, supplier's representative shall make one field inspection and certify, in writing to the Architect, that hardware installation complies with the project documents, approved hardware schedule, and Manufacturer's instructions, and that installation is complete and all hardware items have been properly installed and correctly adjusted, or provide a list of items that require correction.

1.07 DELIVERY, STORAGE, AND HANDLING

- A. Package hardware items individually; label and identify each package with door opening code to match door hardware schedule.

1.08 WARRANTY

- A. See Section 01 7800 - Closeout Submittals for additional warranty requirements.
- B. Provide Manufacturer's Standard Warranty against defects in material and workmanship for period indicated, from Date of Substantial Completion.
 - 1. Closers: Five years, minimum.
 - 2. Locksets and Cylinders: Three years, minimum.
 - 3. Other Hardware: Two years, minimum.

PART 2 PRODUCTS

2.01 RESPONSIBILITY

- A. This specification is intended as a guideline for quality and operation and is not to be construed as a complete list. It is the specific responsibility of the hardware supplier to furnish complete hardware for all openings that is functional, meets the Owner's intended use, and in full

compliance with all State and Local Building Codes, Fire Codes, disability and accessibility codes. Any supplier bidding on this section of the work shall notify the Architect prior to bidding, of any observed discrepancies or will be assumed to have included correct material to make this compliance.

2.02 DESIGN AND PERFORMANCE CRITERIA

- A. Provide specified door hardware as required to make doors fully functional, compliant with applicable codes, and secure to extent indicated.
- B. Provide individual items of single type, of same model, and by same manufacturer.
- C. Provide door hardware products that comply with the following requirements:
 - 1. Applicable provisions of federal, state, and local codes.
 - 2. Accessibility: ADA Standards and ICC A117.1.
 - 3. Products Requiring Electrical Connection: Listed and classified by UL (DIR) as suitable for the purpose specified.
- D. Electrically Operated and/or Controlled Hardware: Provide necessary power supplies, power transfer hinges, relays, and interfaces as required for proper operation; provide wiring between hardware and control components and to building power connection in compliance with NFPA 70.
 - 1. Coordinate the installation, wiring and operation of any automatic door operators and electric strikes with any access control system.
- E. Lock Function: Provide lock and latch function numbers and descriptions of manufacturer's series. Refer to Door Hardware Schedule.
- F. Surface Mounted Closers: Check degree of opening for all closers. Mount closer away from exterior, halls, corridors and public spaces. Notify Architect during the Submittal Review process if specified closers do not comply with this requirement. Unless specifically specified, do not restrict door swing.
- G. Finishes: As identified in Door Hardware Schedule.
- H. Fasteners:
 - 1. Provide fasteners of proper type, size, quantity, and finish that comply with commercially recognized standards for proposed applications, and as follows:
 - a. Mineral Core Wood Doors: Sex bolts.
 - b. Closers at Wood Doors: Sex bolts.
 - c. Concrete and Masonry Substrates: Stainless steel machine screws and lead expansion shields.

2.03 HINGES

- A. Hinges: Provide hinges on every swinging door unless otherwise indicated.
 - 1. Provide five-knuckle full mortise ball-bearing butt hinges unless otherwise indicated.
 - 2. Provide hinges in the quantities indicated.
 - 3. Provide non-removable pins on all outswinging exterior and interior doors.
 - 4. Where electrified hardware is mounted in door leaf, provide power transfer hinges unless otherwise indicated.
- B. Manufacturers:
 - 1. Basis of Design: Ives; an Allegion brand; [____]: www.allegion.com/
 - 2. Substitutions: See Section 01 6000 - Product Requirements.
- C. Grade: Comply with BHMA A156.1, Grade 1.

2.04 ELECTROMAGNETIC LOCKS

- A. Manufacturers:
 - 1. Basis of Design: Schlage; an Assa Abloy Group company: www.assaabloydss.com/#sle.
 - 2. Substitutions: Not permitted.
- B. Electromagnetic Locks: Comply with BHMA A156.23, Grade 1.
 - 1. Holding Force: 600 lbs (272 kgs), minimum.

2. Voltage: 12 VDC, and provide power supplies by same manufacturer as locks.
3. Mounting: Surface mounted to door and frame on secure side, with fasteners, brackets, and spacer bars as required for application.

2.05 LOCK CYLINDERS

- A. Manufacturers:
 1. Basis of Design: Schlage, an Allegion brand: www.allegion.com/us.
 2. Substitutions: Not permitted.
- B. Exterior Cylinders: Schlage Primus to match Owner standards.

2.06 CYLINDRICAL LOCKS

- A. Manufacturers:
 1. Schlage, an Allegion brand: www.allegion.com/us.
 2. Substitutions: Not permitted.

2.07 MORTISE LOCKS

- A. Manufacturers:
 1. Schlage, an Allegion brand: www.allegion.com/us.
 2. Substitutions: Not permitted.

2.08 CLOSERS

- A. Manufacturers; Surface Mounted:
 1. Basis of Design: LCN, an Allegion brand: www.allegion.com/us.
 2. Substitutions: Not permitted.
- B. Closers: Comply with BHMA A156.4, Grade 1.
 1. At outswinging exterior doors, mount closer on interior side of door.

2.09 OVERHEAD STOPS AND HOLDERS

- A. Manufacturers:
 1. DORMA USA, Inc; 900 Series: www.dorma.com/#sle.
 2. Glynn-Johnson, an Allegion brand: www.allegion.com/us.
 3. Substitutions: See Section 01 6000 - Product Requirements.
- B. Overhead Stops and Holders (Door Checks): Comply with BHMA A156.8, Grade 1.

2.10 PROTECTION / KICK PLATES

- A. Manufacturers:
 1. Ives; an Assa Abloy Group company: www.assaabloydss.com.
 2. Hager Companies: www.hagerco.com/#sle.
 3. Trimco: www.trimcohardware.com.
 4. Substitutions: See Section 01 6000 - Product Requirements.
- B. Protection Plates: Comply with BHMA A156.6.
- C. Metal Properties: Stainless steel.
 1. Metal, Heavy Duty: Thickness 0.062 inch (1.57 mm), minimum.
- D. Edges: Beveled, on four sides unless otherwise indicated.
- E. Fasteners: Countersunk screw fasteners.

2.11 THRESHOLDS

- A. Manufacturers:
 1. Pemko; an Assa Abloy Group company: www.assaabloydss.com.
 2. National Guard Products, Inc: www.ngpinc.com.
 3. Zero International, Inc: www.zerointernational.com.
 4. Substitutions: See Section 01 6000 - Product Requirements.
- B. Thresholds: Comply with BHMA A156.21.
 1. Provide threshold at each exterior door, unless otherwise indicated.

2. Type: Interlocking.
3. Material: Aluminum.
4. Threshold Surface: Fluted horizontal grooves across full width.
5. Field cut threshold to profile of frame and width of door sill for tight fit.
6. Provide non-corroding fasteners at exterior locations.

2.12 WEATHERSTRIPPING AND GASKETING

- A. Manufacturers:
 1. Pemko; an Assa Abloy Group company: www.assaabloydss.com.
 2. Hager Companies: www.hagerco.com/#sle.
 3. Ives, an Allegion brand: www.allegion.com/us.
 4. National Guard Products, Inc: www.ngpinc.com.
 5. Zero International, Inc: www.zerointernational.com.
 6. Substitutions: See Section 01 6000 - Product Requirements.
- B. Weatherstripping and Gasketing: Comply with BHMA A156.22.
 1. Head and Jamb Type: Adjustable.
 2. Door Sweep Type: Encased in retainer.
 3. Material: Aluminum, with brush weatherstripping.
 4. Provide weatherstripping on each exterior door at head, jambs, and meeting stiles of door pairs, unless otherwise indicated.
 5. Provide door bottom sweep on each exterior door, unless otherwise indicated.

2.13 SILENCERS

- A. Manufacturers:
 1. Ives, an Allegion brand: www.allegion.com/us.
 2. Rockwood; an Assa Abloy Group company: www.assaabloydss.com.
 3. Substitutions: See Section 01 6000 - Product Requirements.
- B. Silencers: Provide at equal locations on door frames without seals or gaskets to mute sound of door's impact upon closing.
 1. Single Door: Provide three on strike jamb of frame.
 2. Pair of Doors: Provide two on head of frame, one for each door at latch side.
 3. Material: Rubber, gray color.

2.14 FIRE DEPARTMENT LOCK BOX

- A. As specified in section 10 4400 Fire Protection Specialties.

2.15 KEYING

- A. Door Locks: Grand master keyed.
 1. Include construction keying.
- B. Supply keys in the following quantities:
 1. 2 change keys for each lock .
 2. Construction keys as required by Contractor.

2.16 FINISHES

- A. Finishes: Identified in Section 08 0671 - Door Hardware Schedule.

PART 3 EXECUTION

3.01 EXAMINATION

- A. Verify that doors and frames are ready to receive this work; labeled, fire-rated doors and frames are properly installed, and dimensions are as indicated on shop drawings.
- B. Verify that electric power is available to power operated devices and of correct characteristics.

3.02 INSTALLATION

- A. Install hardware in accordance with manufacturer's instructions and applicable codes.
- B. Use templates provided by hardware item manufacturer.

- C. Do not install surface mounted items until application of finishes to substrate are fully completed.
- D. Door Hardware Mounting Heights: Distance from finished floor to center line of hardware item. As indicated in following list; unless noted otherwise in Door Hardware Schedule or on drawings.
 - 1. For Steel Doors and Frames: Install in compliance with DHI (LOCS) recommendations.
- E. Set exterior door thresholds with full-width bead of elastomeric sealant at each point of contact with floor providing a continuous weather seal; anchor thresholds with stainless steel countersunk screws.
 - 1. See Section 07 9200 for additional requirements.

3.03 FIELD QUALITY CONTROL

- A. Perform field inspection and testing under provisions of Section 01 4000 - Quality Requirements.
- B. Provide an Architectural Hardware Consultant (AHC) to inspect installation and certify that hardware and installation has been furnished and installed in accordance with manufacturer's instructions and as specified.

3.04 ADJUSTING

- A. Adjust work under provisions of Section 01 7000 - Execution and Closeout Requirements.
- B. Adjust hardware for smooth operation.
- C. Adjust gasketing for complete, continuous seal; replace if unable to make complete seal.
- D. Test and adjust all Locks and Latches, including Lock Keyways for smooth and easy operation.

3.05 CLEANING

- A. Clean finished hardware in accordance with manufacturer's written instructions after final adjustments have been made.
- B. Clean adjacent surfaces soiled by hardware installation.
- C. Replace items that cannot be cleaned to manufacturer's level of finish quality at no additional cost.

3.06 PROTECTION

- A. Protect finished Work under provisions of Section 01 7000 - Execution and Closeout Requirements.
- B. Do not permit adjacent work to damage hardware or finish.

END OF SECTION

**SECTION 08 7110
DOOR HARDWARE SCHEDULE**

HW SET # 01

Openings

101A 101B

Each door or doors to have:

<u>QTY</u>	<u>DESCRIPTION</u>	<u>CATALOG NUMBER</u>	<u>FINISH</u>	<u>MFR</u>
------------	--------------------	-----------------------	---------------	------------

HW SET # 02

Openings

101C 101D

Each door or doors to have:

<u>QTY</u>	<u>DESCRIPTION</u>	<u>CATALOG NUMBER</u>	<u>FINISH</u>	<u>MFR</u>
3	EA HINGE	5BB1HW 4.5 X 4.5 NRP	630	IVE
1	EA POWER TRANSFER	EPT10 CON	689	VON
1	EA EU MORTISE LOCK	L9092TEU 17A RX CON 12/24 VDC	630	SCH
1	EA FSIC CORE	23-030	626	SCH
1	EA SURFACE CLOSER	4111 SCUSH WMS	689	LCN
1	EA KICK PLATE	8400 10" X 2" LDW B-CS	630	IVE
1	EA RAIN DRIP	142AA	AA	ZER
1	EA GASKETING	488SBK PSA	BK	ZER
1	EA DOOR SWEEP	8198AA	AA	ZER
1	EA THRESHOLD	65A-V3-223	A	ZER
1	EA WIRE HARNESS	CON-192P (FROM EPT TO ELECTRIFIED HARDWARE- VERIFY LENGTH BEFORE ORDERING)		SCH
1	EA WIRE HARNESS	CON-6W FROM INCOMING POWER SUPPLY		SCH
1	EA DOOR CONTACT	679-05HM POWER SUPPLY - WORK OF DIVISION 28 ACCESS CONTROL - WORK OF DIVISION 28	BLK	SCE

OPERATION: OUTSIDE LEVER RELEASED BY CARD READER OR TIME CLOCK.
DOOR IS NOT AN EXIT

HW SET # 03

Openings

102B

Each door or doors to have:

<u>QTY</u>		<u>DESCRIPTION</u>	<u>CATALOG NUMBER</u>	<u>FINISH</u>	<u>MFR</u>
3	EA	HINGE	5BB1HW 4.5 X 4.5 NRP	630	IVE
1	EA	POWER TRANSFER	EPT10 CON	689	VON
1	EA	EU MORTISE LOCK	L9092TEU 17A RX CON 12/24 VDC	630	SCH
1	EA	FSIC CORE	23-030	626	SCH
1	EA	SURFACE CLOSER	4111 SCUSH WMS	689	LCN
1	EA	KICK PLATE	8400 10" X 2" LDW B-CS	630	IVE
1	EA	GASKETING	488SBK PSA	BK	ZER
1	EA	WIRE HARNESS	CON-192P (FROM EPT TO ELECTRIFIED HARDWARE- VERIFY LENGTH BEFORE ORDERING)		SCH
1	EA	WIRE HARNESS	CON-6W FROM INCOMING POWER SUPPLY		SCH
1	EA	DOOR CONTACT	679-05HM POWER SUPPLY - WORK OF DIVISION 28 ACCESS CONTROL - WORK OF DIVISION 28	BLK	SCE

OPERATION: OUTSIDE LEVER RELEASED BY CARD READER OR TIME CLOCK.
DOOR IS NOT AN EXIT

HW SET # 04

Openings

102A

Each door or doors to have:

<u>QTY</u>		<u>DESCRIPTION</u>	<u>CATALOG NUMBER</u>	<u>FINISH</u>	<u>MFR</u>
8	EA	HINGE	5BB1HW 4.5 X 4.5 NRP	630	IVE
2	EA	MANUAL FLUSH BOLT	FB458	626	IVE
1	EA	DUST PROOF STRIKE	DP2	626	IVE
1	EA	STOREROOM LOCK	L9080T 17A	630	SCH
1	EA	FSIC CORE	23-030	626	SCH
2	EA	SURFACE CLOSER	4111 SCUSH	689	LCN
2	EA	KICK PLATE	8400 10" X 2" LDW B-CS	630	IVE
1	EA	RAIN DRIP	142AA	AA	ZER
1	EA	ASTRAGAL	43SP	SP	ZER
2	EA	DOOR SWEEP	8198AA	AA	ZER
1	EA	THRESHOLD	65A-V3-223	A	ZER
2	EA	DOOR CONTACT	679-05HM	BLK	SCE

END OF SCHEDULE

**SECTION 01 6023
SUBSTITUTION REQUEST FORM**

SUBSTITUTION REQUEST: DATE SUBMITTED 6/19/24

1.01 SUBMIT TO: PIVOT ARCHITECTURE, 44 WEST BROADWAY #300, EUGENE OR 97401-3038

A. All Substitution Requests shall be submitted via e-mail to **bwardle@pivotarchitecture.com**.

1.02 PROJECT: SMART Facility Improvements

1.03 SPECIFIED ITEM:

A. SECTION NAME AND NUMBER: Plumbing Fixtures 22 4000

B. PRODUCT TYPE AND NAME AND MODEL:

Trenchify, TPC600

C. PARAGRAPH AND PRODUCT DESCRIPTION: 2.03 Trench Drain

1.04 PROPOSED SUBSTITUTION:

A. MANUFACTURER AND MODEL NUMBER(S):

Dura Trench, 05C24DG & DTPF4-HDBP08ZSA

B. PRODUCT DESCRIPTION: Trench Drain & Grate

C. Attached data includes product description, specifications, drawings, photographs, performance and test data adequate for evaluation of request including identification of applicable data portions. Attached data also includes description of changes to Contract Documents the proposed substitution requires for proper installation.

1.05 UNDERSIGNED CERTIFIES FOLLOWING ITEMS, UNLESS MODIFIED BY ATTACHMENTS, ARE CORRECT:

- A. Proposed substitution does not affect dimensions shown on the drawings.
- B. Undersigned pays for changes to building design, including engineering design, detailing, and construction costs caused by proposed substitution.
- C. Proposed substitution has no adverse effect on other trades, construction schedule, or specified warranty requirements.
- D. Maintenance and service parts are available locally or readily obtainable for proposed substitution.

1.06 UNDERSIGNED FURTHER CERTIFIES FUNCTION, APPEARANCE, AND QUALITY OF PROPOSED SUBSTITUTION ARE EQUIVALENT OR SUPERIOR TO SPECIFIED ITEM.

1.07 UNDERSIGNED FURTHER CERTIFIES THAT THE MANUFACTURER OF THE PROPOSED SUBSTITUTION IS AWARE OF THIS SUBSTITUTION REQUEST AND AGREES TO THE STATEMENTS NOTED ABOVE.

1.08 UNDERSIGNED AGREES THAT THE TERMS AND CONDITIONS FOR SUBSTITUTIONS FOUND IN BIDDING DOCUMENTS APPLY TO THIS PROPOSED SUBSTITUTION.

1.09 SUBMITTED BY:

A. NAME: Christina Erickson

SIGNATURE: _____

B. FIRM NAME: United Sales NW

C. FULL MAILING ADDRESS: 1605 Columbia St Suite 100

D. PHONE: 360-524-6040 E-MAIL: christina@unitedsalesnw

1.10 FOR USE BY ARCHITECT OR ENGINEER

A. APPROVED OR APPROVED AS NOTED BY:
Gustavo Vela-Moreno, KCL Engineering

B. NOT APPROVED BY: _____

C. RECEIVED TOO LATE: _____
D. REMARKS: No exceptions taken
E. DATE OF RESPONSE: June 27, 2024

END OF SECTION

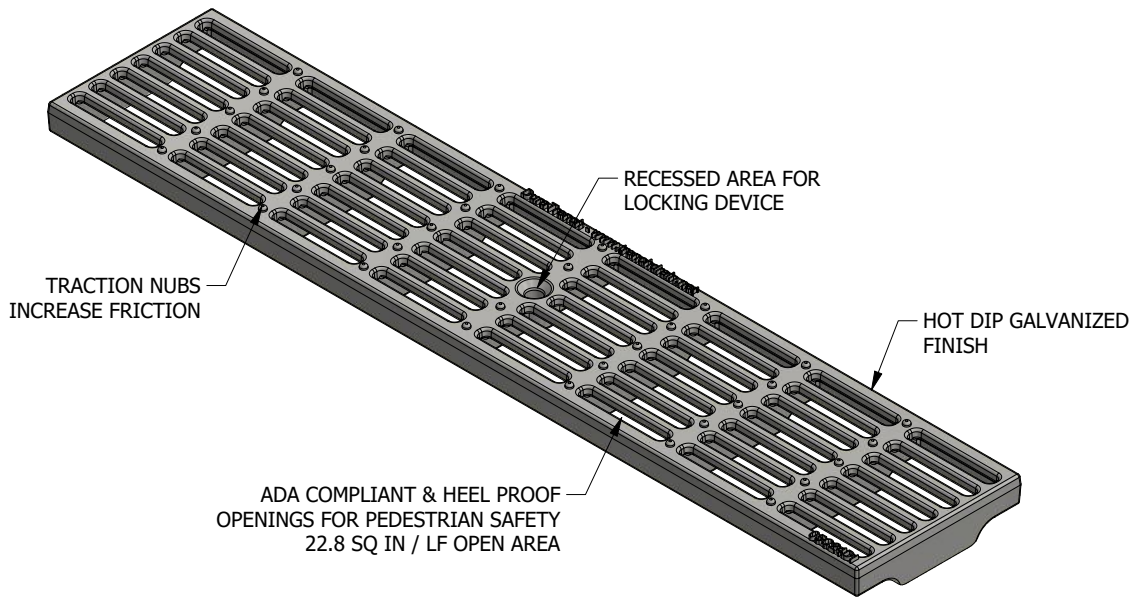

ISOMETRIC VIEW

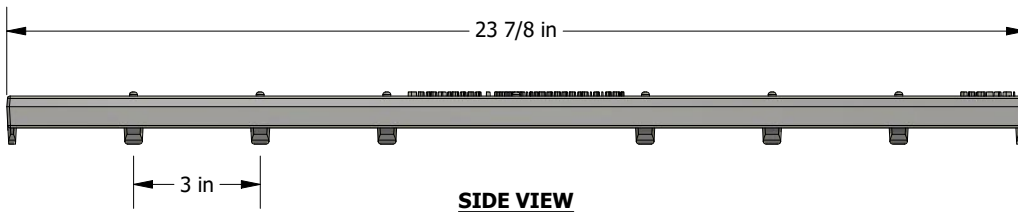

SIDE VIEW

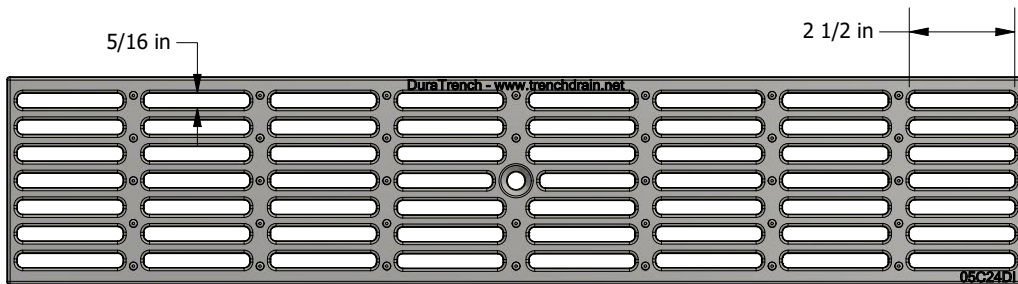

TOP VIEW

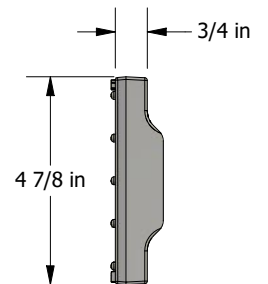

END VIEW

MATERIAL	DUCTILE IRON 65-45-12
COATING	HOT DIP GALVANIZED
LOCKING	BOLT AND TOGGLE
LOAD RATING	DIN CLASS D
ADA / HEEL GUARD	YES

STANDARD TOLERANCES
 0 = +/-0.25
 0.0 = +/-0.25
 0.00 = +/- 0.13



574c Industrial Way N.
 Dallas, GA 30132
 PH: 770-505-6575
www.trenchdrain.net

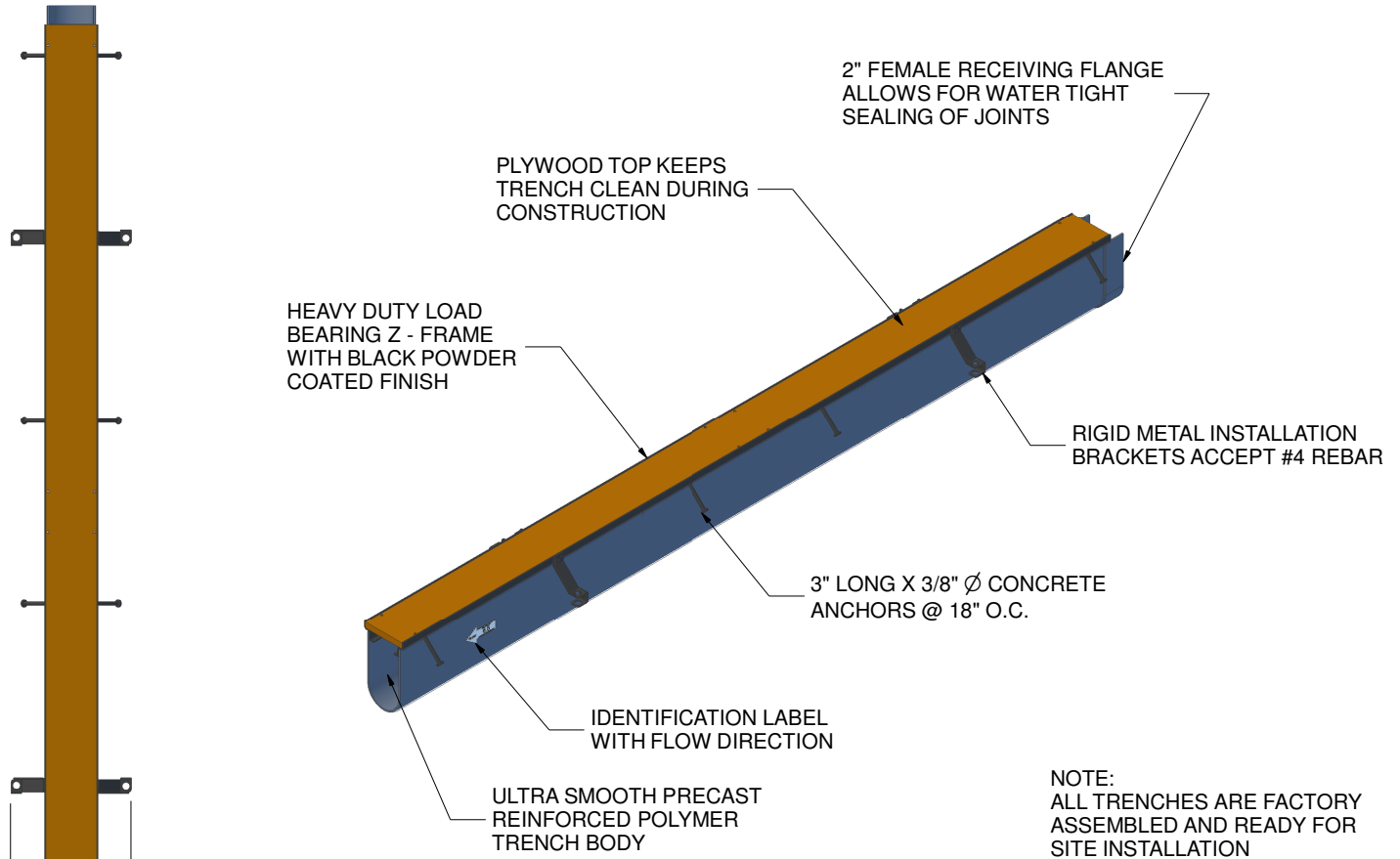

ISOMETRIC VIEW

11 7/8"

TOP VIEW

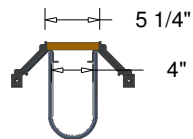

END VIEW

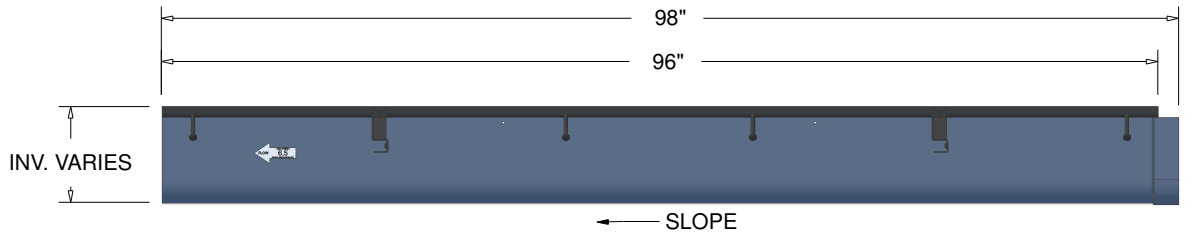

SIDE VIEW

TRENCH MATERIAL	FIBER REINFORCED POLYMER
FRAME MATERIAL	STEEL PER ASTM A-36
FRAME COATING	BLACK POWDER COATING (POLYESTER BASE)
ANCHOR STUDS	3" X 3/8" Ø
INSTALL DEVICE	RIGID STAMPED METAL FOR #4 BARS
LOAD RATING	HEAVY DUTY
SLOPE	0.5% TYP (CUSTOM SLOPE AVAILABLE)

STANDARD TOLERANCES
 0 = +/-0.25
 0.0 = +/-0.25
 0.00 = +/- 0.13



574c Industrial Way N.
 Dallas, GA 30132
 PH: 770-505-6575
www.trenchdrain.net



574C Industrial Way N.
Dallas, GA 30132
(770) 505-6575
(770) 505-6110 Fax

PRODUCT WARRANTY

This Limited Warranty covers Dura-Trench Linear Drain systems (the “Products”) by Eric’s sons and/or its division Eric’s sons “The Drain Brains” (individually and collectively, “Eric’s sons”).

1. **LIMITED ONE YEAR WARRANTY:** Subject to the limitations set for the below, Eric’s sons warrants to its customer (“Buyer”) that the Products will be free from defects or failure caused by improper manufacturing for a period of one (1) year from the date of manufacture. The total warranty period for any Products shall not exceed one (1) year from the date of manufacture.
2. **EXCEPTIONS TO WARRANTY:**
 - A. The Limited Warranty in Section 1 does not cover defects, damage to the Product or Product failure caused by:
 - i. A defect or failure in any product not manufactured by Eric’s sons;
 - ii. Loads in excess of Eric’s sons recommended grate/rail/frame load factor for such Product;
 - iii. Shipping, or improper handling by others;
 - iv. Improper storage, installation, maintenance or repair by others;
 - v. Abuse, abnormal use or accident;
 - vi. Use for a purpose or in a manner for which the Product was not intended; or
 - vii. Improper site design by others.
 - viii. Natural disasters that place the product in conditions for which the product was not designed.
 - B. The Limited Warranty is void if:
 - i. Any materials or other products not provided by, or authorized in writing by Eric’s sons, are used with the Products; or
 - ii. Eric’s sons does not receive timely notice of the alleged defects in accordance with the terms of section 6 below.
3. **EXCLUSIVE REMEDY:** Subject to compliance with the terms in Section 6 below, Eric’s sons will, at its option and in its sole discretion, repair or replace any defective Products. **THE EXCLUSIVE REMEDY UNDER THIS LIMITED WARRANTY, UNDER ANY OTHER EXPRESS WARRANTY NOT NEGATED HEREBY AND UNDER ANY IMPLIED WARRANTIES NOT NEGATED HEREBY (INCLUDING THE IMPLIED WARRANTIES OF**

MERCHANTABILITY AND FITNESS FOR PARTICULAR PURPOSE), IS REPAIR OR REPLACEMENT OF DEFECTIVE PRODUCTS. IN NO EVENT WILL WARRANTY COMPENSATION, OR OTHER DAMAGES AVAILABLE FROM ERIC'SONS, EXCEED THE SALE PRICE RECEIVED BY ERIC'SONS FOR THE PRODUCTS.

4. EXCLUSION OF CONSEQUENTIAL AND INCIDENTAL DAMAGES: THIS LIMITED WARRANTY, ANY OTHER EXPRESS WARRANTY NOT NEGATED HEREBY AND ANY IMPLIED WARRANTY NOT NEGATED HEREBY (INCLUDING THE IMPLIED WARRANTIES OF MERCHANTABILITY AND FITNESS FOR A PARTICULAR PURPOSE), DO NOT COVER, AND ERIC'SONS WILL IN NO EVENT BE LIABLE FOR, INCIDENTAL OR CONSEQUENTIAL DAMAGES, including, but not limited to, loss of profits, the cost of removal, disassembly and shipment of the defective Products, injury to other property, loss of use, or other commercial losses or installation of any replacement Products. Where, due to operation of law, consequential and incidental damages under this Limited Warranty, under any other express warranty not negated hereby or under any implied warranty not negated hereby (INCLUDING THE IMPLIED WARRANTIES OF MERCHANTABILITY AND FITNESS FOR PARTICULAR PURPOSE) cannot be excluded, such damages are expressly limited in amount to the sales price received by Eric'sons for the installation of the Products. This exclusion of consequential and incidental damages, and the provision of this Limited Warranty limiting remedies hereunder to repair or replacement, are independent provisions, and any determination that the limitation of remedies fails of its essential purpose or any other determination that either of the above provisions is unenforceable, shall not be construed to make the other provision unenforceable.
5. EXCLUSION OF OTHER WARRANTIES: this Limited Warranty is in lieu of all other warranties, express or implied. ALL OTHER WARRANTIES, INCLUDING BUT NOT LIMITED TO THE IMPLIED WARRANTIES OF MERCHANTABILITY AND FITNESS FOR A PARTICULAR PURPOSE, ARE EXPRESSLY DISCLAIMED.
6. NOTICE: Eric'sons will not pay for the cost of repair or replacement performed other than in accordance with this Limited Warranty. Subject to the terms of this Limited Warranty, Eric'sons will, at its option and in its sole discretion, repair or replace the defective Products provided;
 - A. The defect is reported to Eric'sons in writing within the applicable one (1) year warranty period;
 - B. Eric'sons authorizes the return of the defective part for replacement or repair; and



574C Industrial Way N.
Dallas, GA 30132
(770) 505-6575
(770) 505-6110 Fax

- C. The defective part is returned to Eric's sons freight and transportation costs prepaid, with a suitable letter and a copy of the purchase invoice. The letter should include a detailed written description of the defect and how and when the Product containing the defective part was used. All shipping and transportation costs associated with the return of the defective part are the responsibility of the Buyer.

Written notice of a Product or a component part believed to be defective as covered by this Limited Warranty should be sent to:

Eric's sons
574C Industrial Way N.
Dallas, GA 30132

And should include Buyer's name and address, proof of purchase, and a brief description of the defects. Eric's sons will ship (freight collect) to Buyer Products repaired or replaced under this Limited Warranty.

7. PRODUCT REPAIR: Eric's sons' obligations under the Limited Warranty to repair any defective Products are subject to the following terms:

- A. All repair work shall be provided by Eric's sons;
- B. Buyer shall provide Eric's sons with a suitable work environment; and
- C. Eric's sons will offer the following insurance coverage covering the Eric's sons personnel performing the repair work.

Workman's compensation and Employee liability

E.L. each Accident	\$ 500,000
E.L. disease – each employee	\$ 500,000
E.L. disease – policy limit	\$ 500,000

Automobile Liability

Combined single limit	\$1,000,000
-----------------------	-------------

General Liability

Each Occurrence	\$1,000,000
Damage to rented property	\$ 300,000
Med. Expense – one person	\$ 10,000
Personal & adv. Injury	\$1,000,000
General aggregate	\$2,000,000

Additional insurance coverage, if required by Buyer, must be purchased by Buyer prior to Eric's sons completing the repair work.

Buyer's failure to purchase such additional insurance or to otherwise provide Eric's sons with a suitable work environment within a commercially reasonable period of time shall relieve Eric's sons of its obligations under the Limited Warranty set forth herein.



574C Industrial Way N.
Dallas, GA 30132
(770) 505-6575
(770) 505-6110 Fax

8. CHOICE OF LAW: This contract shall be governed by, and construed in accordance with, the internal laws and judicial decisions of the State of Georgia, without regard for any choice or conflict of laws considerations.
9. SEVERABILITY: In the event any portion of this Limited Warranty shall be determined to be invalid under any applicable law, such provision shall be deemed null and void and the remainder of this Limited Warranty shall continue in full force and effect.



S.M.A.R.T. Facility Improvements

Jun 24 2024



Table of Contents

Datasheets

New Section			
Type	Manufacturer	Model Number	Pg.
S1/S2	ACUITY BRANDS LIGHTING	DSX0 LED P3 40K 70CRI X MVOLT X X X X	2
W1	ACUITY BRANDS LIGHTING	WDGE2 LED P4 X X MVOLT SRM X X	10



Datasheets

New Section

**SECTION 01 6023
SUBSTITUTION REQUEST FORM**

SUBSTITUTION REQUEST: DATE SUBMITTED 6.24.24

1.01 SUBMIT TO: PIVOT ARCHITECTURE, 44 WEST BROADWAY #300, EUGENE OR 97401-3038

A. All Substitution Requests shall be submitted via e-mail to **bwardle@pivotarchitecture.com**.

1.02 PROJECT: SMART Facility Improvements

1.03 SPECIFIED ITEM: Cree Lighting Edge Square Series

- A. SECTION NAME AND NUMBER: Luminaire Schedule Type S1 / S2
- B. PRODUCT TYPE AND NAME AND MODEL:
Cree Lighting Edge Square Series
- C. PARAGRAPH AND PRODUCT DESCRIPTION: Site Light

1.04 PROPOSED SUBSTITUTION: Acuity Brands DSX Series

- A. MANUFACTURER AND MODEL NUMBER(S):
DSX0 LED P3 40K 70CRI X MVOLT X X X X
- B. PRODUCT DESCRIPTION: Site Light
- C. Attached data includes product description, specifications, drawings, photographs, performance and test data adequate for evaluation of request including identification of applicable data portions. Attached data also includes description of changes to Contract Documents the proposed substitution requires for proper installation.

1.05 UNDERSIGNED CERTIFIES FOLLOWING ITEMS, UNLESS MODIFIED BY ATTACHMENTS, ARE CORRECT:

- A. Proposed substitution does not affect dimensions shown on the drawings.
- B. Undersigned pays for changes to building design, including engineering design, detailing, and construction costs caused by proposed substitution.
- C. Proposed substitution has no adverse effect on other trades, construction schedule, or specified warranty requirements.
- D. Maintenance and service parts are available locally or readily obtainable for proposed substitution.

1.06 UNDERSIGNED FURTHER CERTIFIES FUNCTION, APPEARANCE, AND QUALITY OF PROPOSED SUBSTITUTION ARE EQUIVALENT OR SUPERIOR TO SPECIFIED ITEM.

1.07 UNDERSIGNED FURTHER CERTIFIES THAT THE MANUFACTURER OF THE PROPOSED SUBSTITUTION IS AWARE OF THIS SUBSTITUTION REQUEST AND AGREES TO THE STATEMENTS NOTED ABOVE.

1.08 UNDERSIGNED AGREES THAT THE TERMS AND CONDITIONS FOR SUBSTITUTIONS FOUND IN BIDDING DOCUMENTS APPLY TO THIS PROPOSED SUBSTITUTION.

1.09 SUBMITTED BY:

- A. NAME: Bobby Dennis 
SIGNATURE: _____
- B. FIRM NAME: HL Stearns
- C. FULL MAILING ADDRESS: 5314 NE Irving St. Portland OR, 97213
- D. PHONE: 503.905.6787 E-MAIL: bdennis@hlstearns.com

1.10 FOR USE BY ARCHITECT OR ENGINEER

- A. APPROVED OR APPROVED AS NOTED BY:
Beverly Washburn
- B. NOT APPROVED BY: _____

- C. RECEIVED TOO LATE: _____
- D. REMARKS: No exceptions.
- E. DATE OF RESPONSE: 06/28/2024

END OF SECTION



D-Series Size 0 Legacy LED Area Luminaire



Catalog Number
Notes
Type

Hit the Tab key or mouse over the page to see all interactive elements.

Introduction

The modern styling of the D-Series is striking yet unobtrusive - making a bold, progressive statement even as it blends seamlessly with its environment. The D-Series distills the benefits of the latest in LED technology into a high performance, high efficacy, long-life luminaire.

The outstanding photometric performance results in sites with excellent uniformity, greater pole spacing and lower power density. It is ideal for replacing up to 400W metal halide with typical energy savings of 70% and expected service life of over 100,000 hours.

Specifications

- EPA:** 0.95 ft² (.09 m²)
- Length:** 26" (66.0 cm)
- Width:** 13" (33.0 cm)
- Height₁:** 3" (7.62 cm)
- Height₂:** 7" (17.8 cm)
- Weight (max):** 16 lbs (7.25 kg)

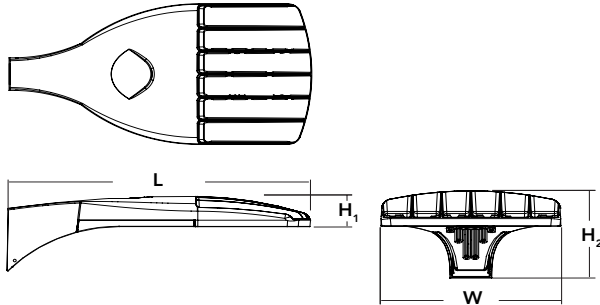

Ordering Information

EXAMPLE: DSX0 LED P6 40K T3M MVOLT SPA NLTAIR2 PIRHN DDBXD G1

DSX0 LED		Color temperature		Distribution		Voltage		Mounting	
Series	LEDs	Color temperature		Distribution		Voltage		Mounting	
DSX0 LED	Forward optics P1 P5 P2 P6 P3 P7 ¹ P4 ¹ Rotated optics P10 ² P12 ² P11 ² P13 ^{1,2}	30K 3000 K 40K 4000 K 50K 5000 K	T1S Type I short (Automotive) T2S Type II short T2M Type II medium T3S Type III short T3M Type III medium T4M Type IV medium TFTM Forward throw medium TSVS Type V very short ³	T5S Type V short ³ T5M Type V medium ³ TSW Type V wide ³ BLC Backlight control ⁴ LCCO Left corner cutoff ⁴ RCCO Right corner cutoff ⁴	MVOLT (120V-277V) ^{5,6} XVOLT (277V-480V) ^{7,8,9} 120 ⁶ 208 ⁶ 240 ⁶ 277 ⁶ 347 ⁶ 480 ⁶	Shipped included SPA Square pole mounting RPA Round pole mounting ¹⁰ WBA Wall bracket ³ SPUMBA Square pole universal mounting adaptor ¹¹ RPUMBA Round pole universal mounting adaptor ¹¹ Shipped separately KMA8 DDBXD U Mast arm mounting bracket adaptor (specify finish) ¹²			

Control options		Other options		Finish (required)		Generation (required)	
Shipped installed NLTAIR2 nLight AIR generation 2 enabled ^{13,14} PIRHN Network, high/low motion/ambient sensor ¹⁵ PER NEMA twist-lock receptacle only (control ordered separate) ¹⁶ PERS Five-pin receptacle only (control ordered separate) ^{16,17} PER7 Seven-pin receptacle only (leads exit fixture) (control ordered separate) ^{16,17} DMG 0-10V dimming extend out back of housing for external control (control ordered separate) ¹⁸	PIR High/low, motion/ambient sensor, 8-15' mounting height, ambient sensor enabled at 5fc ^{19,20} PIRHN High/low, motion/ambient sensor, 15-30' mounting height, ambient sensor enabled at 5fc ^{19,20} PIR1FC3V High/low, motion/ambient sensor, 8-15' mounting height, ambient sensor enabled at 1fc ^{19,20} PIRH1FC3V High/low, motion/ambient sensor, 15-30' mounting height, ambient sensor enabled at 1fc ^{19,20} FAO Field adjustable output ^{19,21}	Shipped installed HS House-side shield ²² SF Single fuse (120, 277, 347V) ⁶ DF Double fuse (208, 240, 480V) ⁶ L90 Left rotated optics ² R90 Right rotated optics ² DDL Diffused drop lens ²² HA 50°C ambient operations ¹ Shipped separately BS Bird spikes ²³ EGS External glare shield	DDBXD Dark bronze DBLXD Black DNAXD Natural aluminum DWHXD White DDBTXD Textured dark bronze DBLBXD Textured black DNATXD Textured natural aluminum DWHGXD Textured white	G1 Generation 1			

Ordering Information

Accessories

Ordered and shipped separately.

DLL127F 1.5 JU	Photocell - SSL twist-lock (120-277V) ²⁴
DLL347F 1.5 CUL JU	Photocell - SSL twist-lock (347V) ²⁴
DLL480F 1.5 CUL JU	Photocell - SSL twist-lock (480V) ²⁴
DSHORT SBK U	Shorting cap ²⁴
DSXH5 20C G1 U	House-side shield for P1, P2, P3 and P4 ²²
DSXH5 30C G1 U	House-side shield for P10, P11, P12 and P13 ²²
DSXH5 40C G1 U	House-side shield for P5, P6 and P7 ²²
DSXDDL G1 U	Diffused drop lens (polycarbonate) ²²
PUMBA DDBXD G1 U*	Square and round pole universal mounting bracket adaptor (specify finish) ²²
KMA8 DDBXD U	Must arm mounting bracket adaptor (specify finish) ²²
DSXOEGS (FINISH) G1 U	External glare shield

For more control options, visit [DTL](#) and [ROAM](#) online.
 Link to [nLight Air 2](#)

NOTES

- HA not available with P4, P7, and P13.
- P10, P11, P12 and P13 and rotated options (L90 or R90) only available together.
- Any Type 5 distribution with photocell, is not available with WBA.
- Not available with HS or DDL.
- MVOLT driver operates on any line voltage from 120-277V (50/60 Hz).
- Single fuse (SF) requires 120V, 277V or 347V. Double fuse (DF) requires 208V, 240V or 480V. XVOLT not available with fusing (SF or DF).
- XVOLT only suitable for use with P4, P7 and P13.
- XVOLT operates with any voltage between 277V and 480V.
- XVOLT not available with fusing (SF or DF) and not available with PIR, PIRH, PIR1FC3V, PIRH1FC3V.
- Suitable for mounting to round poles between 3.5" and 12" diameter.
- Universal mounting brackets intended for retrofit on existing pre-drilled poles only. 1.5 G vibration load rating per ANCI C136.31. Only usable when pole's drill pattern is NOT Lithonia template #8.
- Must order fixture with SPA mounting. KMA8 must be ordered as a separate accessory; see Accessories information. For use with 2-3/8" diameter mast arm (not included).
- Must be ordered with PIRHN.
- Sensor cover available only in dark bronze, black, white and natural aluminum colors.
- Must be ordered with NLTAIR2. For more information on nLight Air 2 visit [this link](#).
- Photocell ordered and shipped as a separate line item from Acuity Brands Controls. See accessories. Shorting Cap included.
- If ROAM[®] node required, it must be ordered and shipped as a separate line item from Acuity Brands Controls. Shorting Cap included.
- DMG not available with PIRHN, PER5, PER7, PIR, PIRH, PIR1FC3V or PIRH1FC3V, FAO.
- Reference Controls Options table on page 4.
- Reference Motion Sensor Default Table on page 4 to see functionality.
- Not available with other dimming controls options.
- Not available with BLC, LCCO and RCCO distribution.
- Must be ordered with fixture for factory pre-drilling.
- Requires luminaire to be specified with PER, PER5 or PER7 option. See Controls Table on page 4.
- For retrofit use only. Only usable when pole's drill pattern is NOT Lithonia template #8.

EGS – External Glare Shield

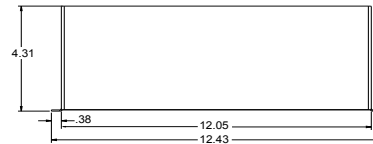
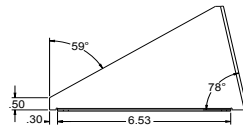
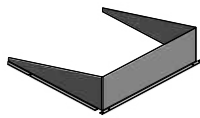

Drilling

HANDHOLE ORIENTATION

(from top of pole)

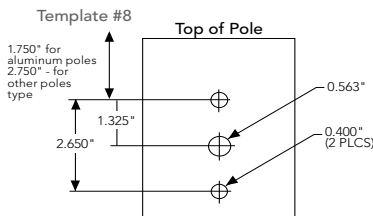
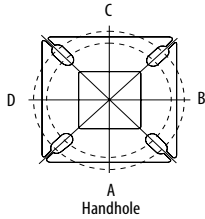

Tenon Mounting Slipfitter

Tenon O.D.	Mounting	Single Unit	2 @ 180	2 @ 90	3 @ 90	3 @ 120	4 @ 90
2-3/8"	RPA	AS3-5 190	AS3-5 280	AS3-5 290	AS3-5 390	AS3-5 320	AS3-5 490
2-7/8"	RPA	AST25-190	AST25-280	AST25-290	AST25-390	AST25-320	AST25-490
4"	RPA	AST35-190	AST35-280	AST35-290	AST35-390	AST35-320	AST35-490

Mounting Option	Drilling Template	Single	2 @ 180	2 @ 90	3 @ 90	3 @ 120	4 @ 90
Head Location		Side B	Side B & D	Side B & C	Side B, C & D	Round Pole Only	Side A, B, C & D
Drill Nomenclature	#8	DM19AS	DM28AS	DM29AS	DM39AS	DM32AS	DM49AS
Minimum Acceptable Outside Pole Dimension							
SPA	#8	2-7/8"	2-7/8"	3.5"	3.5"		3.5"
RPA	#8	2-7/8"	2-7/8"	3.5"	3.5"	3"	3.5"
SPUMBA	#5	2-7/8"	3"	4"	4"		4"
RPUMBA	#5	2-7/8"	3.5"	5"	5"	3.5"	5"

DSX0 Area Luminaire - EPA

*Includes luminaire and integral mounting arm. Other tenons, arms, brackets or other accessories are not included in this EPA data.

Fixture Quantity & Mounting Configuration	Single DM19	2 @ 180 DM28	2 @ 90 DM29	3 @ 90 DM39	3 @ 120 DM32	4 @ 90 DM49
Mounting Type						
DSX0 LED	0.950	1.900	1.830	2.850	2.850	3.544

Photometric Diagrams

To see complete photometric reports or download .ies files for this product, visit Lithonia Lighting's [D-Series Area Size 0 homepage](#).

Isofootcandle plots for the DSX0 LED P6 40K G1. Distances are in units of mounting height (20').

LEGEND
■ 0.1 fc
■ 0.5 fc
■ 1.0 fc

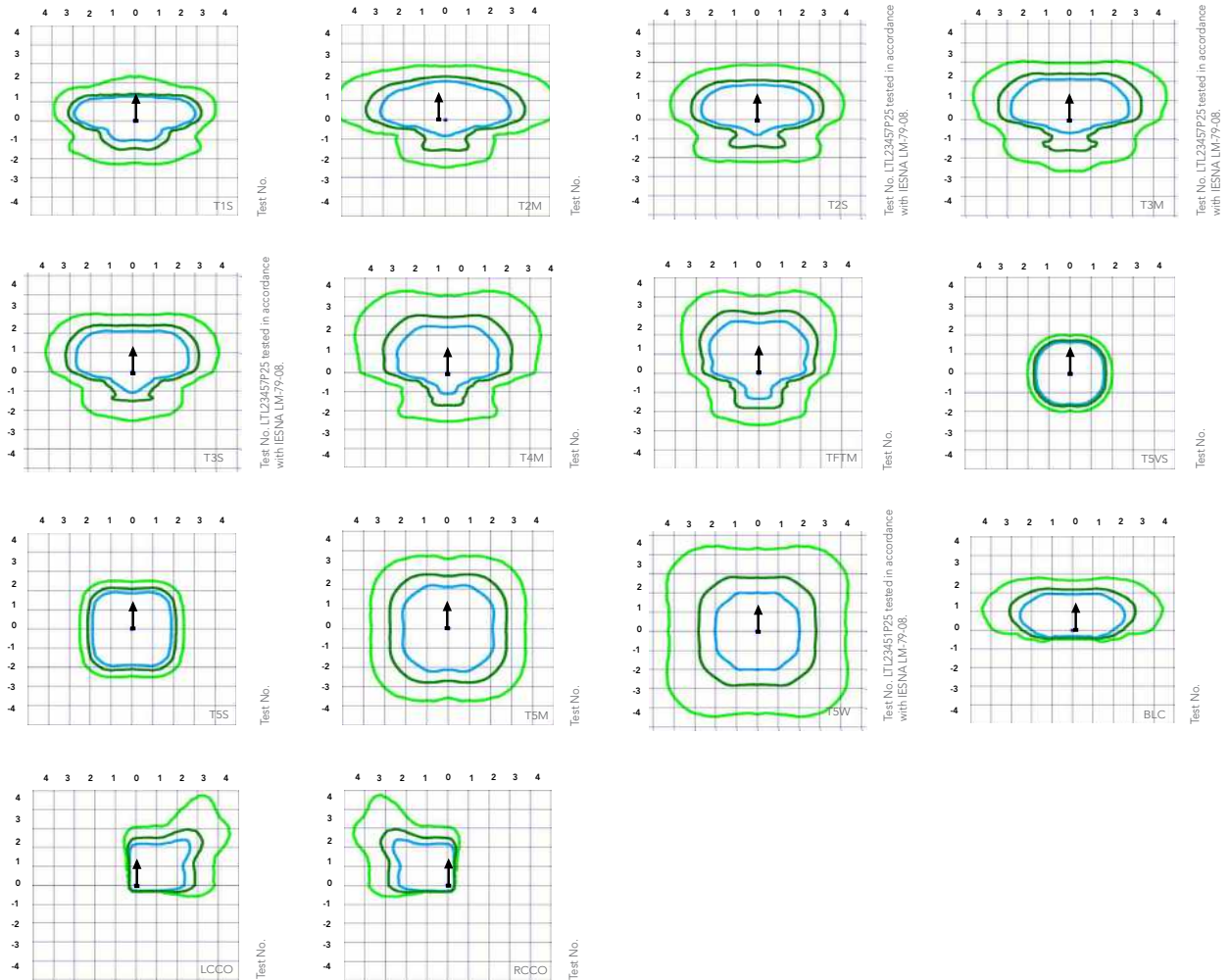

Performance Data

Lumen Ambient Temperature (LAT) Multipliers

Use these factors to determine relative lumen output for average ambient temperatures from 0-40°C (32-104°F).

Ambient		Lumen Multiplier
0°C	32°F	1.04
5°C	41°F	1.04
10°C	50°F	1.03
15°C	59°F	1.02
20°C	68°F	1.01
25°C	77°C	1.00
30°C	86°F	0.99
35°C	95°F	0.98
40°C	104°F	0.97

Projected LED Lumen Maintenance

Data references the extrapolated performance projections for the platforms noted in a **25°C ambient**, based on 10,000 hours of LED testing (tested per IESNA LM-80-08 and projected per IESNA TM-21-11).

To calculate LLF, use the lumen maintenance factor that corresponds to the desired number of operating hours below. For other lumen maintenance values, contact factory.

Operating Hours	Lumen Maintenance Factor
25,000	0.96
50,000	0.92
100,000	0.85

Motion Sensor Default Settings						
Option	Dimmed State	High Level (when triggered)	Photocell Operation	Dwell Time	Ramp-up Time	Ramp-down Time
PIR or PIRH	3V (37%) Output	10V (100%) Output	Enabled @ 5FC	5 min	3 sec	5 min
*PIR1FC3V or PIRH1FC3V	3V (37%) Output	10V (100%) Output	Enabled @ 1FC	5 min	3 sec	5 min

*for use when motion sensor is used as dusk to dawn control.

Controls Options

Nomenclature	Description	Functionality	Primary control device	Notes
FAO	Field adjustable output device installed inside the luminaire; wired to the driver dimming leads.	Allows the luminaire to be manually dimmed, effectively trimming the light output.	FAO device	Cannot be used with other controls options that need the 0-10V leads
DS	Drivers wired independently for 50/50 luminaire operation	The luminaire is wired to two separate circuits, allowing for 50/50 operation.	Independently wired drivers	Requires two separately switched circuits. Consider nLight AIR as a more cost effective alternative.
PERS or PER7	Twist-lock photocell receptacle	Compatible with standard twist-lock photocells for dusk to dawn operation, or advanced control nodes that provide 0-10V dimming signals.	Twist-lock photocells such as DLL Elite or advanced control nodes such as ROAM.	Pins 4 & 5 to dimming leads on driver, Pins 6 & 7 are capped inside luminaire
PIR or PIRH	Motion sensors with integral photocell. PIR for 8-15' mounting; PIRH for 15-30' mounting	Luminaires dim when no occupancy is detected.	Acuity Controls SBGR	Also available with PIRH1FC3V when the sensor photocell is used for dusk-to-dawn operation.
NLTAIR2 PIRHN	nLight AIR enabled luminaire for motion sensing, photocell and wireless communication.	Motion and ambient light sensing with group response. Scheduled dimming with motion sensor over-ride when wirelessly connected to the nLight Edyipse.	nLight Air rSDGR	nLight AIR sensors can be programmed and commissioned from the ground using the CIAIRity Pro app.

Electrical Load

Performance Package	LED Count	Drive Current	Wattage	Current (A)						
				120	208	240	277	347	480	
Forward Optics (Non-Rotated)	P1	20	530	38	0.32	0.18	0.15	0.15	0.10	0.08
	P2	20	700	49	0.41	0.23	0.20	0.19	0.14	0.11
	P3	20	1050	71	0.60	0.37	0.32	0.27	0.21	0.15
	P4	20	1400	92	0.77	0.45	0.39	0.35	0.28	0.20
	P5	40	700	89	0.74	0.43	0.38	0.34	0.26	0.20
	P6	40	1050	134	1.13	0.65	0.55	0.48	0.39	0.29
	P7	40	1300	166	1.38	0.80	0.69	0.60	0.50	0.37
Rotated Optics (Requires L90 or R90)	P10	30	530	53	0.45	0.26	0.23	0.21	0.16	0.12
	P11	30	700	72	0.60	0.35	0.30	0.27	0.20	0.16
	P12	30	1050	104	0.88	0.50	0.44	0.39	0.31	0.23
	P13	30	1300	128	1.08	0.62	0.54	0.48	0.37	0.27

Performance Data

Lumen Output

Lumen values are from photometric tests performed in accordance with IESNA LM-79-08. Data is considered to be representative of the configurations shown, within the tolerances allowed by Lighting Facts. Contact factory for performance data on any configurations not shown here.

Forward Optics																							
Power Package	LED Count	Drive Current	System Watts	Dist. Type	30K (3000 K, 70 CRI)					40K (4000 K, 70 CRI)					50K (5000 K, 70 CRI)								
					Lumens	B	U	G	LPW	Lumens	B	U	G	LPW	Lumens	B	U	G	LPW				
P1	20	530	38W	T1S	4,369	1	0	1	115	4,706	1	0	1	124	4,766	1	0	1	125				
				T2S	4,387	1	0	1	115	4,726	1	0	1	124	4,785	1	0	1	126				
				T2M	4,364	1	0	1	115	4,701	1	0	1	124	4,761	1	0	1	125				
				T3S	4,376	1	0	1	115	4,714	1	0	1	124	4,774	1	0	1	126				
				T3M	4,248	1	0	1	112	4,577	1	0	1	120	4,634	1	0	1	122				
				T4M	4,281	1	0	1	113	4,612	1	0	2	121	4,670	1	0	2	123				
				TFTM	4,373	1	0	1	115	4,711	1	0	2	124	4,771	1	0	2	126				
				TSVS	4,548	2	0	0	120	4,900	2	0	0	129	4,962	2	0	0	131				
				TSS	4,552	2	0	0	120	4,904	2	0	0	129	4,966	2	0	0	131				
				TSM	4,541	3	0	1	120	4,891	3	0	1	129	4,953	3	0	1	130				
				TSW	4,576	3	0	2	120	4,929	3	0	2	130	4,992	3	0	2	131				
				BLC	3,586	1	0	1	94	3,863	1	0	1	102	3,912	1	0	1	103				
				LCCO	2,668	1	0	1	70	2,874	1	0	2	76	2,911	1	0	2	77				
				RCCO	2,668	1	0	1	70	2,874	1	0	2	76	2,911	1	0	2	77				
				P2	20	700	49W	T1S	5,570	1	0	1	114	6,001	1	0	1	122	6,077	2	0	2	124
								T2S	5,593	1	0	1	114	6,025	1	0	1	123	6,102	1	0	1	124
								T2M	5,564	1	0	2	114	5,994	1	0	2	122	6,070	2	0	2	125
								T3S	5,580	1	0	2	114	6,011	1	0	2	123	6,087	1	0	2	124
T3M	5,417	1	0					2	111	5,835	1	0	2	119	5,909	2	0	2	121				
T4M	5,458	1	0					2	111	5,880	1	0	2	120	5,955	1	0	2	122				
TFTM	5,576	1	0					2	114	6,007	1	0	2	123	6,083	1	0	2	124				
TSVS	5,799	2	0					0	118	6,247	2	0	0	127	6,327	2	0	0	129				
TSS	5,804	2	0					0	118	6,252	2	0	0	128	6,332	2	0	1	129				
TSM	5,789	3	0					1	118	6,237	3	0	1	127	6,316	3	0	1	129				
TSW	5,834	3	0					2	119	6,285	3	0	2	128	6,364	3	0	2	130				
BLC	4,572	1	0					1	93	4,925	1	0	1	101	4,987	1	0	1	102				
LCCO	3,402	1	0					2	69	3,665	1	0	2	75	3,711	1	0	2	76				
RCCO	3,402	1	0					2	69	3,665	1	0	2	75	3,711	1	0	2	76				
P3	20	1050	71W					T1S	7,833	2	0	2	110	8,438	2	0	2	119	8,545	2	0	2	120
								T2S	7,865	2	0	2	111	8,473	2	0	2	119	8,580	2	0	2	121
								T2M	7,825	2	0	2	110	8,429	2	0	2	119	8,536	2	0	2	120
								T3S	7,846	2	0	2	111	8,452	2	0	2	119	8,559	2	0	2	121
				T3M	7,617	2	0	2	107	8,205	2	0	2	116	8,309	2	0	2	117				
				T4M	7,675	2	0	2	108	8,269	2	0	2	116	8,373	2	0	2	118				
				TFTM	7,841	2	0	2	110	8,447	2	0	2	119	8,554	2	0	2	120				
				TSVS	8,155	3	0	0	115	8,785	3	0	0	124	8,896	3	0	0	125				
				TSS	8,162	3	0	1	115	8,792	3	0	1	124	8,904	3	0	1	125				
				TSM	8,141	3	0	2	115	8,770	3	0	2	124	8,881	3	0	2	125				
				TSW	8,204	3	0	2	116	8,838	4	0	2	124	8,950	4	0	2	126				
				BLC	6,429	1	0	2	91	6,926	1	0	2	98	7,013	1	0	2	99				
				LCCO	4,784	1	0	2	67	5,153	1	0	2	73	5,218	1	0	2	73				
				RCCO	4,784	1	0	2	67	5,153	1	0	2	73	5,218	1	0	2	73				
				P4	20	1400	92W	T1S	9,791	2	0	2	106	10,547	2	0	2	115	10,681	2	0	2	116
								T2S	9,831	2	0	2	107	10,590	2	0	2	115	10,724	2	0	2	117
								T2M	9,780	2	0	2	106	10,536	2	0	2	115	10,669	2	0	2	116
								T3S	9,807	2	0	2	107	10,565	2	0	2	115	10,698	2	0	2	116
T3M	9,521	2	0					2	103	10,256	2	0	2	111	10,386	2	0	2	113				
T4M	9,594	2	0					2	104	10,335	2	0	3	112	10,466	2	0	3	114				
TFTM	9,801	2	0					2	107	10,558	2	0	2	115	10,692	2	0	2	116				
TSVS	10,193	3	0					1	111	10,981	3	0	1	119	11,120	3	0	1	121				
TSS	10,201	3	0					1	111	10,990	3	0	1	119	11,129	3	0	1	121				
TSM	10,176	4	0					2	111	10,962	4	0	2	119	11,101	4	0	2	121				
TSW	10,254	4	0					3	111	11,047	4	0	3	120	11,186	4	0	3	122				
BLC	8,036	1	0					2	87	8,656	1	0	2	94	8,766	1	0	2	95				
LCCO	5,979	1	0					2	65	6,441	1	0	2	70	6,523	1	0	3	71				
RCCO	5,979	1	0					2	65	6,441	1	0	2	70	6,523	1	0	3	71				

Performance Data

Lumen Output

Lumen values are from photometric tests performed in accordance with IESNA LM-79-08. Data is considered to be representative of the configurations shown, within the tolerances allowed by Lighting Facts. Contact factory for performance data on any configurations not shown here.

Forward Optics

Power Package	LED Count	Drive Current	System Watts	Dist. Type	30K (3000 K, 70 CRI)					40K (4000 K, 70 CRI)					50K (5000 K, 70 CRI)								
					Lumens	B	U	G	LPW	Lumens	B	U	G	LPW	Lumens	B	U	G	LPW				
P5	40	700	89W	T1S	10,831	2	0	2	122	11,668	2	0	2	131	11,816	2	0	2	133				
				T2S	10,876	2	0	2	122	11,716	2	0	2	132	11,864	2	0	2	133				
				T2M	10,820	2	0	2	122	11,656	2	0	2	131	11,803	2	0	2	133				
				T3S	10,849	2	0	2	122	11,687	2	0	2	131	11,835	2	0	2	133				
				T3M	10,532	2	0	2	118	11,346	2	0	2	127	11,490	2	0	2	129				
				T4M	10,613	2	0	3	119	11,434	2	0	3	128	11,578	2	0	3	130				
				TFTM	10,842	2	0	2	122	11,680	2	0	2	131	11,828	2	0	2	133				
				TSVS	11,276	3	0	1	127	12,148	3	0	1	136	12,302	3	0	1	138				
				TSS	11,286	3	0	1	127	12,158	3	0	1	137	12,312	3	0	1	138				
				TSM	11,257	4	0	2	126	12,127	4	0	2	136	12,280	4	0	2	138				
				TSW	11,344	4	0	3	127	12,221	4	0	3	137	12,375	4	0	3	139				
				BLC	8,890	1	0	2	100	9,576	1	0	2	108	9,698	1	0	2	109				
				LCCO	6,615	1	0	3	74	7,126	1	0	3	80	7,216	1	0	3	81				
				RCCO	6,615	1	0	3	74	7,126	1	0	3	80	7,216	1	0	3	81				
				P6	40	1050	134W	T1S	14,805	3	0	3	110	15,949	3	0	3	119	16,151	3	0	3	121
								T2S	14,865	3	0	3	111	16,014	3	0	3	120	16,217	3	0	3	121
T2M	14,789	3	0					3	110	15,932	3	0	3	119	16,134	3	0	3	120				
T3S	14,829	2	0					3	111	15,975	3	0	3	119	16,177	3	0	3	121				
T3M	14,396	3	0					3	107	15,509	3	0	3	116	15,705	3	0	3	117				
T4M	14,507	2	0					3	108	15,628	3	0	3	117	15,826	3	0	3	118				
TFTM	14,820	2	0					3	111	15,965	3	0	3	119	16,167	3	0	3	121				
TSVS	15,413	4	0					1	115	16,604	4	0	1	124	16,815	4	0	1	125				
TSS	15,426	3	0					1	115	16,618	4	0	1	124	16,828	4	0	1	126				
TSM	15,387	4	0					2	115	16,576	4	0	2	124	16,786	4	0	2	125				
TSW	15,506	4	0					3	116	16,704	4	0	3	125	16,915	4	0	3	126				
BLC	12,151	1	0					2	91	13,090	1	0	2	98	13,255	1	0	2	99				
LCCO	9,041	1	0					3	67	9,740	1	0	3	73	9,863	1	0	3	74				
RCCO	9,041	1	0					3	67	9,740	1	0	3	73	9,863	1	0	3	74				
P7	40	1300	166W					T1S	17,023	3	0	3	103	18,338	3	0	3	110	18,570	3	0	3	112
								T2S	17,092	3	0	3	103	18,413	3	0	3	111	18,646	3	0	3	112
				T2M	17,005	3	0	3	102	18,319	3	0	3	110	18,551	3	0	3	112				
				T3S	17,051	3	0	3	103	18,369	3	0	3	111	18,601	3	0	3	112				
				T3M	16,553	3	0	3	100	17,832	3	0	3	107	18,058	3	0	3	109				
				T4M	16,681	3	0	3	100	17,969	3	0	3	108	18,197	3	0	3	110				
				TFTM	17,040	3	0	3	103	18,357	3	0	4	111	18,590	3	0	4	112				
				TSVS	17,723	4	0	1	107	19,092	4	0	1	115	19,334	4	0	1	116				
				TSS	17,737	4	0	2	107	19,108	4	0	2	115	19,349	4	0	2	117				
				TSM	17,692	4	0	2	107	19,059	4	0	2	115	19,301	4	0	2	116				
				TSW	17,829	5	0	3	107	19,207	5	0	3	116	19,450	5	0	3	117				
				BLC	13,971	2	0	2	84	15,051	2	0	2	91	15,241	2	0	2	92				
				LCCO	10,396	1	0	3	63	11,199	1	0	3	67	11,341	1	0	3	68				
				RCCO	10,396	1	0	3	63	11,199	1	0	3	67	11,341	1	0	3	68				

Performance Data

Lumen Output

Lumen values are from photometric tests performed in accordance with IESNA LM-79-08. Data is considered to be representative of the configurations shown, within the tolerances allowed by Lighting Facts. Contact factory for performance data on any configurations not shown here.

Rotated Optics																							
Power Package	LED Count	Drive Current	System Watts	Dist. Type	30K (3000 K, 70 CRI)					40K (4000 K, 70 CRI)					50K (5000 K, 70 CRI)								
					Lumens	B	U	G	LPW	Lumens	B	U	G	LPW	Lumens	B	U	G	LPW				
P10	30	530	53W	T1S	6,727	2	0	2	127	7,247	3	0	3	137	7,339	3	0	3	138				
				T2S	6,809	3	0	3	128	7,336	3	0	3	138	7,428	3	0	3	140				
				T2M	6,689	3	0	3	126	7,205	3	0	3	136	7,297	3	0	3	138				
				T3S	6,805	3	0	3	128	7,331	3	0	3	138	7,424	3	0	3	140				
				T3M	6,585	3	0	3	124	7,094	3	0	3	134	7,183	3	0	3	136				
				T4M	6,677	3	0	3	126	7,193	3	0	3	136	7,284	3	0	3	137				
				TFTM	6,850	3	0	3	129	7,379	3	0	3	139	7,472	3	0	3	141				
				TSVS	6,898	3	0	0	130	7,431	3	0	0	140	7,525	3	0	0	142				
				TSS	6,840	2	0	1	129	7,368	2	0	1	139	7,461	2	0	1	141				
				T5M	6,838	3	0	1	129	7,366	3	0	2	139	7,460	3	0	2	141				
				TSW	6,777	3	0	2	128	7,300	3	0	2	138	7,393	3	0	2	139				
				BLC	5,626	2	0	2	106	6,060	2	0	2	114	6,137	2	0	2	116				
				LCCO	4,018	1	0	2	76	4,328	1	0	2	82	4,383	1	0	2	83				
				RCCO	4,013	3	0	3	76	4,323	3	0	3	82	4,377	3	0	3	83				
				P11	30	700	72W	T1S	8,594	3	0	3	119	9,258	3	0	3	129	9,376	3	0	3	130
								T2S	8,699	3	0	3	121	9,371	3	0	3	130	9,490	3	0	3	132
T2M	8,545	3	0					3	119	9,205	3	0	3	128	9,322	3	0	3	129				
T3S	8,694	3	0					3	121	9,366	3	0	3	130	9,484	3	0	3	132				
T3M	8,412	3	0					3	117	9,062	3	0	3	126	9,177	3	0	3	127				
T4M	8,530	3	0					3	118	9,189	3	0	3	128	9,305	3	0	3	129				
TFTM	8,750	3	0					3	122	9,427	3	0	3	131	9,546	3	0	3	133				
TSVS	8,812	3	0					0	122	9,493	3	0	0	132	9,613	3	0	0	134				
TSS	8,738	3	0					1	121	9,413	3	0	1	131	9,532	3	0	1	132				
T5M	8,736	3	0					2	121	9,411	3	0	2	131	9,530	3	0	2	132				
TSW	8,657	4	0					2	120	9,326	4	0	2	130	9,444	4	0	2	131				
BLC	7,187	3	0					3	100	7,742	3	0	3	108	7,840	3	0	3	109				
LCCO	5,133	1	0					2	71	5,529	1	0	2	77	5,599	1	0	2	78				
RCCO	5,126	3	0					3	71	5,522	3	0	3	77	5,592	3	0	3	78				
P12	30	1050	104W					T1S	12,149	3	0	3	117	13,088	3	0	3	126	13,253	3	0	3	127
								T2S	12,297	3	0	3	118	13,247	3	0	3	127	13,415	3	0	3	129
				T2M	12,079	4	0	4	116	13,012	4	0	4	125	13,177	4	0	4	127				
				T3S	12,290	3	0	3	118	13,239	4	0	4	127	13,407	4	0	4	129				
				T3M	11,891	4	0	4	114	12,810	4	0	4	123	12,972	4	0	4	125				
				T4M	12,058	4	0	4	116	12,990	4	0	4	125	13,154	4	0	4	126				
				TFTM	12,369	4	0	4	119	13,325	4	0	4	128	13,494	4	0	4	130				
				TSVS	12,456	3	0	1	120	13,419	3	0	1	129	13,589	4	0	1	131				
				TSS	12,351	3	0	1	119	13,306	3	0	1	128	13,474	3	0	1	130				
				T5M	12,349	4	0	2	119	13,303	4	0	2	128	13,471	4	0	2	130				
				TSW	12,238	4	0	3	118	13,183	4	0	3	127	13,350	4	0	3	128				
				BLC	10,159	3	0	3	98	10,944	3	0	3	105	11,083	3	0	3	107				
				LCCO	7,256	1	0	3	70	7,816	1	0	3	75	7,915	1	0	3	76				
				RCCO	7,246	3	0	3	70	7,806	4	0	4	75	7,905	4	0	4	76				
				P13	30	1300	128W	T1S	14,438	3	0	3	113	15,554	3	0	3	122	15,751	3	0	3	123
								T2S	14,614	3	0	3	114	15,744	4	0	4	123	15,943	4	0	4	125
T2M	14,355	4	0					4	112	15,465	4	0	4	121	15,660	4	0	4	122				
T3S	14,606	4	0					4	114	15,735	4	0	4	123	15,934	4	0	4	124				
T3M	14,132	4	0					4	110	15,224	4	0	4	119	15,417	4	0	4	120				
T4M	14,330	4	0					4	112	15,438	4	0	4	121	15,633	4	0	4	122				
TFTM	14,701	4	0					4	115	15,836	4	0	4	124	16,037	4	0	4	125				
TSVS	14,804	4	0					1	116	15,948	4	0	1	125	16,150	4	0	1	126				
TSS	14,679	3	0					1	115	15,814	3	0	1	124	16,014	3	0	1	125				
T5M	14,676	4	0					2	115	15,810	4	0	2	124	16,010	4	0	2	125				
TSW	14,544	4	0					3	114	15,668	4	0	3	122	15,866	4	0	3	124				
BLC	7,919	3	0					3	62	8,531	3	0	3	67	8,639	3	0	3	67				
LCCO	5,145	1	0					2	40	5,543	1	0	2	43	5,613	1	0	2	44				
RCCO	5,139	3	0					3	40	5,536	3	0	3	43	5,606	3	0	3	44				

FEATURES & SPECIFICATIONS

INTENDED USE

The sleek design of the D-Series Size 0 reflects the embedded high performance LED technology. It is ideal for many commercial and municipal applications, such as parking lots, plazas, campuses, and pedestrian areas.

CONSTRUCTION

Single-piece die-cast aluminum housing has integral heat sink fins to optimize thermal management through conductive and convective cooling. Modular design allows for ease of maintenance and future light engine upgrades. The LED driver is mounted in direct contact with the casting to promote low operating temperature and long life. Housing is completely sealed against moisture and environmental contaminants (IP65). Low EPA (0.95 ft²) for optimized pole wind loading.

FINISH

Exterior parts are protected by a zinc-infused Super Durable TGIC thermoset powder coat finish that provides superior resistance to corrosion and weathering. A tightly controlled multi-stage process ensures a minimum 3 mils thickness for a finish that can withstand extreme climate changes without cracking or peeling. Available in both textured and non-textured finishes.

OPTICS

Precision-molded proprietary acrylic lenses are engineered for superior area lighting distribution, uniformity, and pole spacing. Light engines are available in 3000 K, 4000 K or 5000 K (70 CRI) configurations. The D-Series Size 0 has zero uplight and qualifies as a Nighttime Friendly™ product, meaning it is consistent with the LEED® and Green Globes™ criteria for eliminating wasteful uplight.

ELECTRICAL

Light engine(s) configurations consist of high-efficacy LEDs mounted to metal-core circuit boards to maximize heat dissipation and promote long life (up to L85/100,000 hours at 25°C). Class 1 electronic drivers are designed to have a power factor >90%, THD <20%, and an expected life of 100,000 hours with <1% failure rate. Easily serviceable 10kV surge protection device meets a minimum Category C Low operation (per ANSI/IEEE C62.41.2).

STANDARD CONTROLS

The DSX0 LED area luminaire has a number of control options. DSX Size 0, comes standard with 0-10V dimming driver. Dusk to dawn controls can be utilized via optional NEMA twist-lock photocell receptacles. Integrated motion sensors with on-board photocells feature field-adjustable programming and are suitable for mounting heights up to 30 feet.

nLIGHT AIR CONTROLS

The DSX0 LED area luminaire is also available with nLight® AIR for the ultimate in wireless control. This powerful controls platform provides out-of-the-box basic motion sensing and photocontrol functionality and is suitable for mounting heights up to 40 feet. Once commissioned using a smartphone and the easy-to-use CLAIRITY app, nLight AIR equipped luminaires can be grouped, resulting in motion sensor and photocell group response without the need for additional equipment. Scheduled dimming with motion sensor over-ride can be achieved when used with the nLight Eclipse. Additional information about nLight Air can be found [here](#).

INSTALLATION

Included mounting block and integral arm facilitate quick and easy installation. Stainless steel bolts fasten the mounting block securely to poles and walls, enabling the D-Series Size 0 to withstand up to a 3.0 G vibration load rating per ANSI C136.31. The D-Series Size 0 utilizes the AERIS™ series pole drilling pattern (template #8). Optional terminal block and NEMA photocontrol receptacle are also available.

LISTINGS

UL listed to meet U.S. and Canadian standards. UL Listed for wet locations. Light engines are IP66 rated; luminaire is IP65 rated. Rated for -40°C to 50°C ambient with HA option. U.S. Patent No. D672,492 S. International patent pending.

DesignLights Consortium® (DLC) Premium qualified product and DLC qualified product. Not all versions of this product may be DLC Premium qualified or DLC qualified. Please check the DLC Qualified Products List at www.designlights.org/QPL to confirm which versions are qualified.

International Dark-Sky Association (IDA) Fixture Seal of Approval (FSA) is available for all products on this page utilizing 3000K color temperature only.

GOVERNMENT PROCUREMENT

BAA – Buy America(n) Act: Product with the BAA option qualifies as a domestic end product under the Buy American Act as implemented in the FAR and DFARS. Product with the BAA option also qualifies as manufactured in the United States under DOT Buy America regulations.

BABA – Build America Buy America: Product with the BAA option also qualifies as produced in the United States under the definitions of the Build America, Buy America Act.

Please refer to www.acuitybrands.com/buy-american for additional information.

WARRANTY

5-year limited warranty. This is the only warranty provided and no other statements in this specification sheet create any warranty of any kind. All other express and implied warranties are disclaimed. Complete warranty terms located at: www.acuitybrands.com/support/warranty/terms-and-conditions

Note: Actual performance may differ as a result of end-user environment and application.

All values are design or typical values, measured under laboratory conditions at 25 °C.

Specifications subject to change without notice.



COMMERCIAL OUTDOOR

One Lithonia Way • Conyers, Georgia 30012 • Phone: 1-800-705-SERV (7378) • www.lithonia.com
© 2011-2024 Acuity Brands Lighting, Inc. All rights reserved.

DSX0 LED G1
Rev. 03/26/24
Page 8 of 8

**SECTION 01 6023
SUBSTITUTION REQUEST FORM**

SUBSTITUTION REQUEST: DATE SUBMITTED 6.24.24

1.01 SUBMIT TO: PIVOT ARCHITECTURE, 44 WEST BROADWAY #300, EUGENE OR 97401-3038

A. All Substitution Requests shall be submitted via e-mail to **bwardle@pivotarchitecture.com**.

1.02 PROJECT: SMART Facility Improvements

1.03 SPECIFIED ITEM: Cree Lighting OSQ Series

A. SECTION NAME AND NUMBER: Luminaire Schedule Type W1

B. PRODUCT TYPE AND NAME AND MODEL:
Cree Lighting OSQ Series

C. PARAGRAPH AND PRODUCT DESCRIPTION: Wall pack

1.04 PROPOSED SUBSTITUTION: Acuity Brands DSX Series

A. MANUFACTURER AND MODEL NUMBER(S):

WDGE2 LED P4 X X MVOLT SRM X X

B. PRODUCT DESCRIPTION: Wall pack

C. Attached data includes product description, specifications, drawings, photographs, performance and test data adequate for evaluation of request including identification of applicable data portions. Attached data also includes description of changes to Contract Documents the proposed substitution requires for proper installation.

1.05 UNDERSIGNED CERTIFIES FOLLOWING ITEMS, UNLESS MODIFIED BY ATTACHMENTS, ARE CORRECT:

- A. Proposed substitution does not affect dimensions shown on the drawings.
- B. Undersigned pays for changes to building design, including engineering design, detailing, and construction costs caused by proposed substitution.
- C. Proposed substitution has no adverse effect on other trades, construction schedule, or specified warranty requirements.
- D. Maintenance and service parts are available locally or readily obtainable for proposed substitution.

1.06 UNDERSIGNED FURTHER CERTIFIES FUNCTION, APPEARANCE, AND QUALITY OF PROPOSED SUBSTITUTION ARE EQUIVALENT OR SUPERIOR TO SPECIFIED ITEM.

1.07 UNDERSIGNED FURTHER CERTIFIES THAT THE MANUFACTURER OF THE PROPOSED SUBSTITUTION IS AWARE OF THIS SUBSTITUTION REQUEST AND AGREES TO THE STATEMENTS NOTED ABOVE.

1.08 UNDERSIGNED AGREES THAT THE TERMS AND CONDITIONS FOR SUBSTITUTIONS FOUND IN BIDDING DOCUMENTS APPLY TO THIS PROPOSED SUBSTITUTION.

1.09 SUBMITTED BY:

A. NAME: Bobby Dennis 

SIGNATURE: _____

B. FIRM NAME: HL Stearns

C. FULL MAILING ADDRESS: 5314 NE Irving St. Portland OR, 97213

D. PHONE: 503.905.6787 E-MAIL: bdennis@hlstearns.com

1.10 FOR USE BY ARCHITECT OR ENGINEER

A. APPROVED OR APPROVED AS NOTED BY:

B. NOT APPROVED BY: _____

- C. RECEIVED TOO LATE: _____
- D. REMARKS: _____
- E. DATE OF RESPONSE: _____

END OF SECTION



WDGE2 LED

Architectural Wall Sconce

Visual Comfort Optic



Catalog Number
Notes
Type

Hit the Tab key or mouse over the page to see all interactive elements.

Specifications

- Depth (D1):** 7"
- Depth (D2):** 1.5"
- Height:** 9"
- Width:** 11.5"
- Weight:** 13.5 lbs (without options)

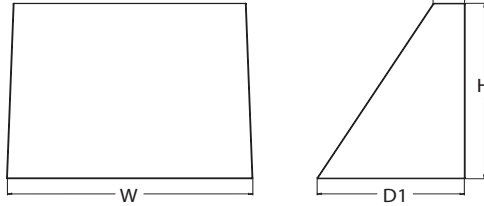

Introduction

The WDGE2 LED family is designed to meet specifier's every wall-mounted lighting need in a widely accepted shape that blends with any architecture. The clean rectilinear design comes in four sizes with lumen packages ranging from 1,200 to 25,000 lumens, providing a true site-wide solution. Embedded with nLight® AIR wireless controls, the WDGE family provides additional energy savings and code compliance.

WDGE2 delivers up to 6,000 lumens with a soft, non-pixelated light source, creating a visually comfortable environment. When combined with multiple integrated emergency battery backup options, including an 18W cold temperature option, the WDGE2 becomes the ideal wall-mounted lighting solution for pedestrian scale applications in any environment.



Items marked by a shaded background qualify for the Design Select program and ship in 15 days or less. To learn more about Design Select, visit www.acuitybrands.com/designselect. *See ordering tree for details

WDGE LED Family Overview

Luminaire	Optics	Standard EM, 0°C	Cold EM, -20°C	Sensor	Approximate Lumens (4000K, 80CRI)						
					P0	P1	P2	P3	P4	P5	P6
WDGE1 LED	Visual Comfort	4W		--	750	1,200	2,000	--	--	--	--
WDGE2 LED	Visual Comfort	10W	18W	Standalone / nLight	--	1,200	2,000	3,000	4,500	6,000	--
WDGE3 LED	Precision Refractive	10W	18W	Standalone / nLight	700	1,200	2,000	3,200	4,200	--	--
WDGE4 LED	Precision Refractive	15W	18W	Standalone / nLight	6,000	7,500	8,500	10,000	12,000	--	--
WDGE4 LED	Precision Refractive			Standalone / nLight	--	12,000	16,000	18,000	20,000	22,000	25,000

Ordering Information

EXAMPLE: WDGE2 LED P3 40K 80CRI VF MVOLT SRM DDBXD

Series	Package	Color Temperature	CRI	Distribution	Voltage	Mounting	
WDGE2 LED	P1 ¹	P1SW	27K 2700K	80CRI	MVOLT	Shipped included SRM Surface mounting bracket ICW Indirect Canopy/Ceiling Washer bracket (dry/damp locations only) ⁴	
	P2 ¹	P2SW	30K 3000K	90CRI			347 ³
	P3 ¹	P3SW	35K 3500K		VF Visual comfort forward throw VW Visual comfort wide		480 ³
	P4 ¹	Door with small window (SW) is required to accommodate sensors. See page 2 for more details.	40K 4000K				Shipped separately AWS 3/8inch Architectural wall spacer PBBW Surface-mounted back box (top, left, right conduit entry). Use when there is no junction box available.
	P5 ¹		50K ² 5000K				

Options		Standalone Sensors/Controls (only available with P1SW, P2SW & P3SW)		Networked Sensors/Controls (only available with P1SW, P2SW & P3SW)	
E4WH	Emergency battery backup, Certified in CA Title 20 MAEDBS (4W, 0°C min)	PIR	Bi-level (100/35%) motion sensor for 8-15' mounting heights. Intended for use on switched circuits with external dusk to dawn switching.	NLTAIR2 PIR	Embedded wireless controls by nLight with Passive Infrared Occ sensor and on/off photocell for 8-15' mounting heights.
E10WH	Emergency battery backup, Certified in CA Title 20 MAEDBS (10W, 5°C min)	PIRH	Bi-level (100/35%) motion sensor for 15-30' mounting heights. Intended for use on switched circuits with external dusk to dawn switching.	NLTAIR2 PIRH	Embedded wireless controls by nLight with Passive Infrared Occ sensor and on/off photocell for 15-30' mounting heights.
E20WC	Emergency battery backup, Certified in CA Title 20 MAEDBS (18W, -20°C min)	PIR1FC3V	Bi-level (100/35%) motion sensor for 8-15' mounting heights with photocell pre-programmed for dusk to dawn operation.	NLTAIREM2 PIR	Embedded wireless controls by nLight with UL924 listed emergency operation, Passive Infrared Occ sensor and on/off photocell for 8-15' mounting heights.
PE	Photocell, Button Type ⁵	PIRH1FC3V	Bi-level (100/35%) motion sensor for 15-30' mounting heights with photocell pre-programmed for dusk to dawn operation.	NLTAIREM2 PIRH	Embedded wireless controls by nLight with UL924 listed emergency operation, Passive Infrared Occ sensor and on/off photocell for 15-30' mounting heights.
DS	Dual switching (comes with 2 drivers and 2 light engines; see page 3 for details) ⁶				
DMG	0-10V dimming wires pulled outside fixture (for use with an external control, ordered separately) ⁷				
BCE	Bottom conduit entry for back box (PBBW). Total of 4 entry points.				
DSLE	Dual Switching (1 Driver, 2 Light Engines)				
CCE	Coastal Construction				



COMMERCIAL OUTDOOR

One Lithonia Way • Conyers, Georgia 30012 • Phone: 1-800-705-SERV (7378) • www.lithonia.com
 © 2019-2024 Acuity Brands Lighting, Inc. All rights reserved.

WDGE2 LED
 Rev. 05/30/24

Accessories

Ordered and shipped separately.

- WDGEAWS DDBXD WDGE 3/8inch Architectural Wall Spacer (specify finish)
- WDGE2P8BW DDBXD U WDGE2 surface-mounted back box (specify finish)

NOTES

- 1 P1-P5 not available with sensors/controls. Sensors/controls only available with P1SW, P2SW and P3SW.
- 2 50K not available in 90CRI.
- 3 347V and 480V not available with E4WH, E10WH, E20WC, DS or DSLE.
- 4 Not qualified for DLC. Not available with emergency battery backup or sensors/controls.
- 5 PE not available in 480V or with sensors/controls.
- 6 DS option not available with E4WH, E10WH, E20WC or sensors/controls.
- 7 DMG option not available with sensors/controls.
- 8 Available with MVOLT only and only rated to 25C ambient.

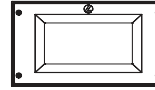

Default configuration with no sensors/controls.

Power Packages: P1, P2, P3, P4, P5

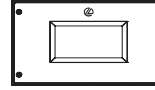

Small Window (SW) configuration

Power Packages: P1SW, P2SW, P3SW

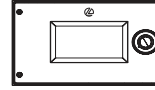

Configuration with sensors/controls

Power Packages: P1SW, P2SW, P3SW

Performance Data

Lumen Output

Lumen values are from photometric tests performed in accordance with IESNA LM-79-08. Data is considered to be representative of the configurations shown, within the tolerances allowed by Lighting Facts. Contact factory for performance data on any configurations not shown here.

Performance Package	System Watts	Dist. Type	27K (2700K, 80 CRI)					30K (3000K, 80 CRI)					35K (3500K, 80 CRI)					40K (4000K, 80 CRI)					50K (5000K, 80 CRI)				
			Lumens	LPW	B	U	G	Lumens	LPW	B	U	G	Lumens	LPW	B	U	G	Lumens	LPW	B	U	G	Lumens	LPW	B	U	G
P1 / P1SW	10W	VF	1,166	119	0	0	0	1,209	123	0	0	0	1,251	128	0	0	0	1,256	128	0	0	0	1,254	128	0	0	0
		VW	1,197	122	0	0	0	1,241	126	0	0	0	1,284	131	0	0	0	1,289	131	0	0	0	1,286	131	0	0	0
P2 / P2SW	15W	VF	1,878	129	1	0	0	1,947	134	1	0	0	2,015	139	1	0	0	2,023	139	1	0	0	2,019	139	1	0	0
		VW	1,927	133	1	0	0	1,997	137	1	0	0	2,067	142	1	0	0	2,075	143	1	0	0	2,071	143	1	0	0
P3 / P3SW	23W	VF	2,908	129	1	0	0	3,015	134	1	0	0	3,119	138	1	0	0	3,132	139	1	0	0	3,126	139	1	0	0
		VW	2,983	132	1	0	0	3,093	137	1	0	0	3,200	142	1	0	0	3,213	143	1	0	0	3,206	142	1	0	0
P4	35W	VF	4,096	117	1	0	1	4,247	121	1	0	1	4,394	126	1	0	1	4,412	126	1	0	1	4,403	126	1	0	1
		VW	4,202	120	1	0	0	4,357	125	1	0	1	4,508	129	1	0	1	4,526	129	1	0	1	4,517	129	1	0	1
P5	48W	VF	5,567	115	1	0	1	5,772	119	1	0	1	5,972	123	1	0	1	5,996	124	1	0	1	5,984	124	1	0	1
		VW	5,711	118	1	0	1	5,921	122	1	0	1	6,127	126	1	0	1	6,151	127	1	0	1	6,139	127	1	0	1

Electrical Load

Performance Package	System Watts	Current (A)					
		120V	208V	240V	277V	347V	480V
P1 / P1SW	10W	0.082	0.049	0.043	0.038	--	--
	13W	--	--	--	--	0.046	0.033
P2 / P2SW	15W	0.132	0.081	0.072	0.064	--	--
	18W	--	--	--	--	0.056	0.041
P3 / P3SW	23W	0.195	0.114	0.100	0.088	--	--
	26W	--	--	--	--	0.079	0.058
P4	35W	0.302	0.175	0.152	0.134	--	--
	38W	--	--	--	--	0.115	0.086
P5	48W	0.434	0.241	0.211	0.184	--	--
	52W	--	--	--	--	0.157	0.119

Lumen Multiplier for 90CRI

CCT	Multiplier
27K	0.845
30K	0.867
35K	0.845
40K	0.885
50K	0.898

Lumen Output in Emergency Mode (4000K, 80 CRI)

Option	Dist. Type	Lumens
E4WH	VF	646
	VW	647
E10WH	VF	1,658
	VW	1,701
E20WC	VF	2,840
	VW	2,913

Lumen Ambient Temperature (LAT) Multipliers

Use these factors to determine relative lumen output for average ambient temperatures from 0-40°C (32-104°F).

Ambient	Lumen Multiplier
0°C / 32°F	1.03
10°C / 50°F	1.02
20°C / 68°F	1.01
25°C / 77°F	1.00
30°C / 86°F	0.99
40°C / 104°F	0.98

Projected LED Lumen Maintenance

Data references the extrapolated performance projections for the platforms noted in a 25°C ambient, based on 10,000 hours of LED testing (tested per IESNA LM-80-08 and projected per IESNA TM-21-11).

To calculate LLF, use the lumen maintenance factor that corresponds to the desired number of operating hours below. For other lumen maintenance values, contact factory.

Operating Hours	0	25,000	50,000	100,000
Lumen Maintenance Factor	1.0	>0.96	>0.95	>0.91

Photometric Diagrams

To see complete photometric reports or download .ies files for this product, visit the Lithonia Lighting WDGE LED homepage. Tested in accordance with IESNA LM-79 and LM-80 standards.

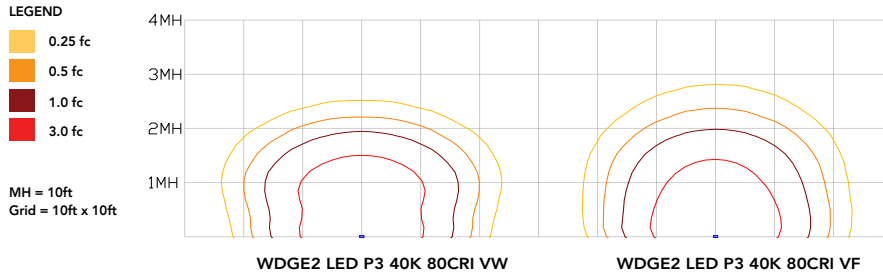

Emergency Egress Options

Emergency Battery Backup

The emergency battery backup is integral to the luminaire — no external housing required! This design provides reliable emergency operation while maintaining the aesthetics of the product. All emergency battery backup configurations include an independent secondary driver with an integral relay to immediately detect loss of normal power and automatically energize the luminaire. The emergency battery will power the luminaire for a minimum duration of 90 minutes (maximum duration of three hours) from the time normal power is lost and maintain a minimum of 60% of the light output at the end of 90 minutes.

Applicable codes: NFPA 70/NEC – section 700.16, NFPA 101 Life Safety Code Section 7.9

The examples below show illuminance of 1 fc average and 0.1 fc minimum in emergency mode with E10WH or E20WC and VF distribution.

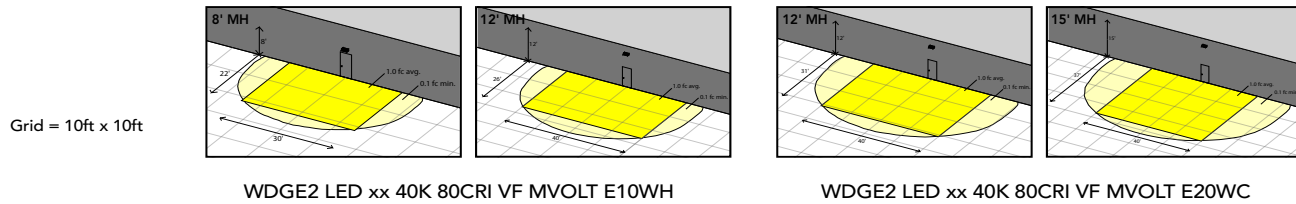

Dual Switching (DS) Option

The dual switching option offers operational redundancy that certain codes require. With this option the luminaire comes integrated with two drivers and two light engines. These work completely independent to each other so that a failure of any individual component does not cause the whole luminaire to go dark.

Applicable codes: NFPA 70/NEC – section 700.16, NFPA 101 Life Safety Code Section 7.9

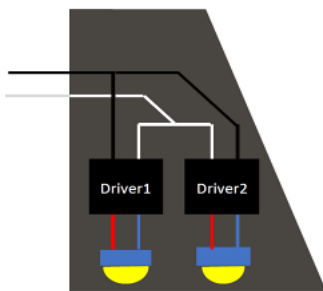

Dual Switching Light Engine (DSLE) Option

The dual switching option offers operational redundancy that certain codes require. With this option the luminaire comes integrated with one driver and two light engines. These work completely independent to each other so that a failure of either light engine does not cause the whole luminaire to go dark.

Applicable codes: NFPA 70/NEC – section 700.16, NFPA 101 Life Safety Code Section 7.9

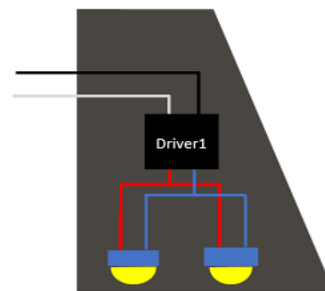

Control / Sensor Options

Motion/Ambient Sensor (PIR, PIRH)

Motion/Ambient sensor (Sensor Switch MSOD) is integrated into the the luminaire. The sensor provides both Motion and Daylight based dimming of the luminaire. For motion detection, the sensor utilizes 100% Digital Passive Infrared (PIR) technology that is tuned for walking size motion while preventing false tripping from the environment. The integrated photocell enables additional energy savings during daytime periods when there is sufficient daylight. Optimize sensor coverage by either selecting PIR or PIRH option. PIR option comes with a sensor lens that is optimized to provide maximum coverage for mounting heights between 8-15ft, while PIRH is optimized for 15-40ft mounting height.

Networked Control (NLTAIR2)

nLight® AIR is a wireless lighting controls platform that allows for seamless integration of both indoor and outdoor luminaires. Five-tier security architecture, 900 MHz wireless communication and app (CLAIRITY™ Pro) based configurability combined together make nLight® AIR a secure, reliable and easy to use platform.

PIR

HIGH VIEW

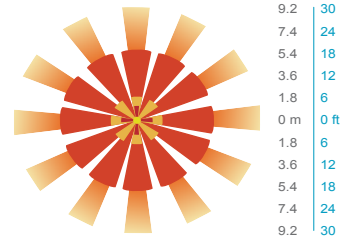
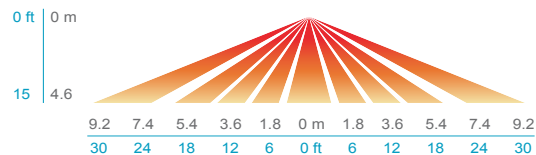

PIRH

SIDE VIEW

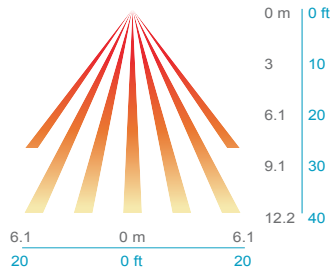

TOP VIEW



Option	Dim Level	High Level (when triggered)	Photocell Operation	Motion Time Delay	Ramp-down Time	Ramp-up Time
PIR or PIRH	Motion - 3V (37% of full output) Photocell - 0V (turned off)	10V (100% output)	Enabled @ 5fc	5 min	5 min	Motion - 3 sec Photocell - 45 sec
PIR1FC3V, PIRH1FC3V	Motion - 3V (37% of full output) Photocell - 0V (turned off)	10V (100% output)	Enabled @ 1fc	5 min	5 min	Motion - 3 sec Photocell - 45 sec
NLTAIR2 PIR, NLTAIR2 PIRH (out of box)	Motion - 3V (37% of full output) Photocell - 0V (turned off)	10V (100% output)	Enabled @ 5fc	7.5 min	5 min	Motion - 3 sec Photocell - 45 sec

UL 924 Response – nLight AIR Devices with EM Option

- NLTAIREM2 devices will remain at their high-end trim and ignore wireless lighting control commands, unless a normal-power-sensed (NPS) broadcast is received at least every 8 seconds.
- Using the CLAIRITY+ mobile app, NLTAIREM2 devices must be associated with a group that includes a normal power sensing device to receive NPS broadcasts.
- The non-emergency devices, NLTAIR2 PIR and NLTAIR2 PIRH, with version 3.4 or later firmware can be used for normal power sensing.

Mounting, Options & Accessories



**NLTAIR2 PIR – nLight AIR
Motion/Ambient Sensor**

D = 7"
H = 11"
W = 11.5"



PBBW – Surface-Mounted Back Box
Use when there is no junction box available.

D = 1.75"
H = 9"
W = 11.5"



AWS – 3/8inch Architectural Wall Spacer

D = 0.38"
H = 4.4"
W = 7.5"

FEATURES & SPECIFICATIONS

INTENDED USE

Common architectural look, with clean rectilinear shape, of the WDGE LED was designed to blend with any type of construction, whether it be tilt-up, frame or brick. Applications include commercial offices, warehouses, hospitals, schools, malls, restaurants, and other commercial buildings.

CONSTRUCTION

The single-piece die-cast aluminum housing integrates secondary heat sinks to optimize thermal transfer from the internal light engine heat sinks and promote long life. The driver is mounted in direct contact with the casting for a low operating temperature and long life. The die-cast door frame is fully gasketed with a one-piece solid silicone gasket to keep out moisture and dust, providing an IP66 rating for the luminaire.

FINISH

Exterior painted parts are protected by a zinc-infused Super Durable TGIC thermoset powder coat finish that provides superior resistance to corrosion and weathering. A tightly controlled multi-stage process ensures a 3 mils thickness for a finish that can withstand extreme climate changes without cracking or peeling. Standard Super Durable colors include dark bronze, black, natural aluminum, sandstone and white. Available in textured and non-textured finishes.

OPTICS

Well crafted reflector optics allow the light engine to be recessed within the luminaire, providing visual comfort, superior distribution, uniformity, and spacing in wall-mount applications. The WDGE LED has zero uplight and qualifies as a Nighttime Friendly™ product, meaning it is consistent with the LEED® and Green Globes™ criteria for eliminating wasteful uplight.

ELECTRICAL

Light engine consists of high-efficiency LEDs mounted to metal-core circuit boards to maximize heat dissipation and promote long life (up to L91/100,000 hours at 25°C). The electronic driver has a power factor of >90%, THD <20%. Luminaire comes with built in 6kV surge protection, which meets a minimum Category C low exposure (per ANSI/IEEE C62.41.2). Fixture ships standard with 0-10v dimmable driver.

INSTALLATION

A universal mounting plate with integral mounting support arms allows the fixture to hinge down for easy access while making wiring connections. The 3/8" Architectural Wall Spacer (AWS) can be used to create a floating appearance or to accommodate small imperfections in the wall surface. The ICW option can be used to mount the luminaire inverted for indirect lighting in dry and damp locations. Design can withstand up to a 1.5 G vibration load rating per ANSI C136.31.

LISTINGS

CSA certified to U.S. and Canadian standards. Luminaire is IP66 rated. PIR options are rated for wet location. Rated for -40°C minimum ambient. DesignLights Consortium® (DLC) Premium qualified product and DLC qualified product. Not all versions of this product may be DLC Premium qualified or DLC qualified. Please check the DLC Qualified Products List at www.designlights.org/QPL to confirm which versions are qualified. International Dark-Sky Association (IDA) Fixture Seal of Approval (FSA) is available for all products on this page utilizing 2700K and 3000K color temperature only and SRM mounting only.

GOVERNMENT PROCUREMENT

BABA – Build America Buy America: Product qualifies as produced in the United States under the definitions of the Build America, Buy America Act. Please refer to www.acuitybrands.com/buy-american for additional information.

WARRANTY

5-year limited warranty. This is the only warranty provided and no other statements in this specification sheet create any warranty of any kind. All other express and implied warranties are disclaimed. Complete warranty terms located at: www.acuitybrands.com/support/warranty/terms-and-conditions

Note: Actual performance may differ as a result of end-user environment and application. All values are design or typical values, measured under laboratory conditions at 25 °C. Specifications subject to change without notice.

PRINTED ON: 4/24/2024 11:21 AM FROM FILE: C:\USERS\USER1670488\WSP_0365\WILSONVILLE SMART BASE EXPANSION - GENERAL\ADD\WORKING\FACILITIES\CIVIL\WORKING\PP-CIVIL - FFD.DWG BY: TAURO, ERIC



1 SITE PLAN

EQUIPMENT SCHEDULE	
EQUIPMENT	DESCRIPTION
PUMP SKID	UL LISTED CONTROL PANEL, CR 32 HIGH PRESSURE PUMP, CR-5 PUMP AND 2 CHEMICAL PUMPS. FUSIBLE DISCONNECT - 400 AMP (FLA 176) - PUMP SKID FROM BUILDING MAIN POWER PULL POWER WIRES AND GROUND WIRE IN CONDUIT TO LINE SIDE OF DISCONNECT, 4' A.F.F. TO BOTTOM OF DISCONNECT. FROM LOAD SIDE OF DISCONNECT TO THE APPROPRIATELY LABELED TERMINALS IN THE UL CONTROL PANEL OF PUMP SKID PULL CAT5e ETHERNET WIRE FROM CUSTOMER NETWORK SERVER LOCATION, TO PUMP SKID PANEL
WATER SOFTENER	CULLIGAN MODEL HET-120; 115 VOLT OUTLET - 20 AMP
RECLAIM SKID	100 GALLON/MIN WITH UL CONTROL PANEL FUSIBLE DISCONNECT - 30 AMP (FLA 24) - RECLAIM SKID FROM BUILDING MAIN POWER PULL POWER WIRES AND GROUND WIRE IN CONDUIT TO LINE SIDE OF DISCONNECT. DISCONNECT TO 4' A.F.F. TO BOTTOM OF BOX. FROM LOAD SIDE OF DISCONNECT TO APPROPRIATELY LABELED TERMINALS IN THE UL CONTROL PANEL OF RECLAIM SKID. SERVICE DISCONNECT - 30 AMP - TRANSFER PUMP FROM UL CONTROL PANEL OF RECLAIM SKID IN CONDUIT PULL POWER WIRES AND GROUND WIRE TO LINE SIDE OF SERVICE DISCONNECT, 4' A.F.F. TO BOTTOM OF SERVICE DISCONNECT. FROM LOAD SIDE OF DISCONNECT IN CONDUIT TO TRANSFER PUMP
ENTRY SYSTEM	ENTRY CONTROL JUNCTION BOX, "J" BOX 12"x12"x4" PVC - 8' A.F.F. PULL IN 1" CONDUIT 3 QTY. #14 AWG. POWER AND GROUND WIRES, 2 QTY. BELDEN (8723) WIRES AND 1 QTY. CAT5e WIRE, FROM UL CONTROL PANEL OF PUMP SKID FROM ENTRY CONTROL JUNCTION BOX, PULL 2 QTY. BELDEN (8723) WIRES IN 3/4" CONDUIT TO ENTRY CONTROL TRAFFIC LIGHT - 8' A.F.F. INSTALL THE ENTRY KEY SYSTEM OUTSIDE ON POLE (2) PULL 3 QTY. #14 AWG. WIRES AND 1 QTY. CAT5e WIRES IN 3/4" CONDUIT UNDERGROUND FROM THE JUNCTION BOX

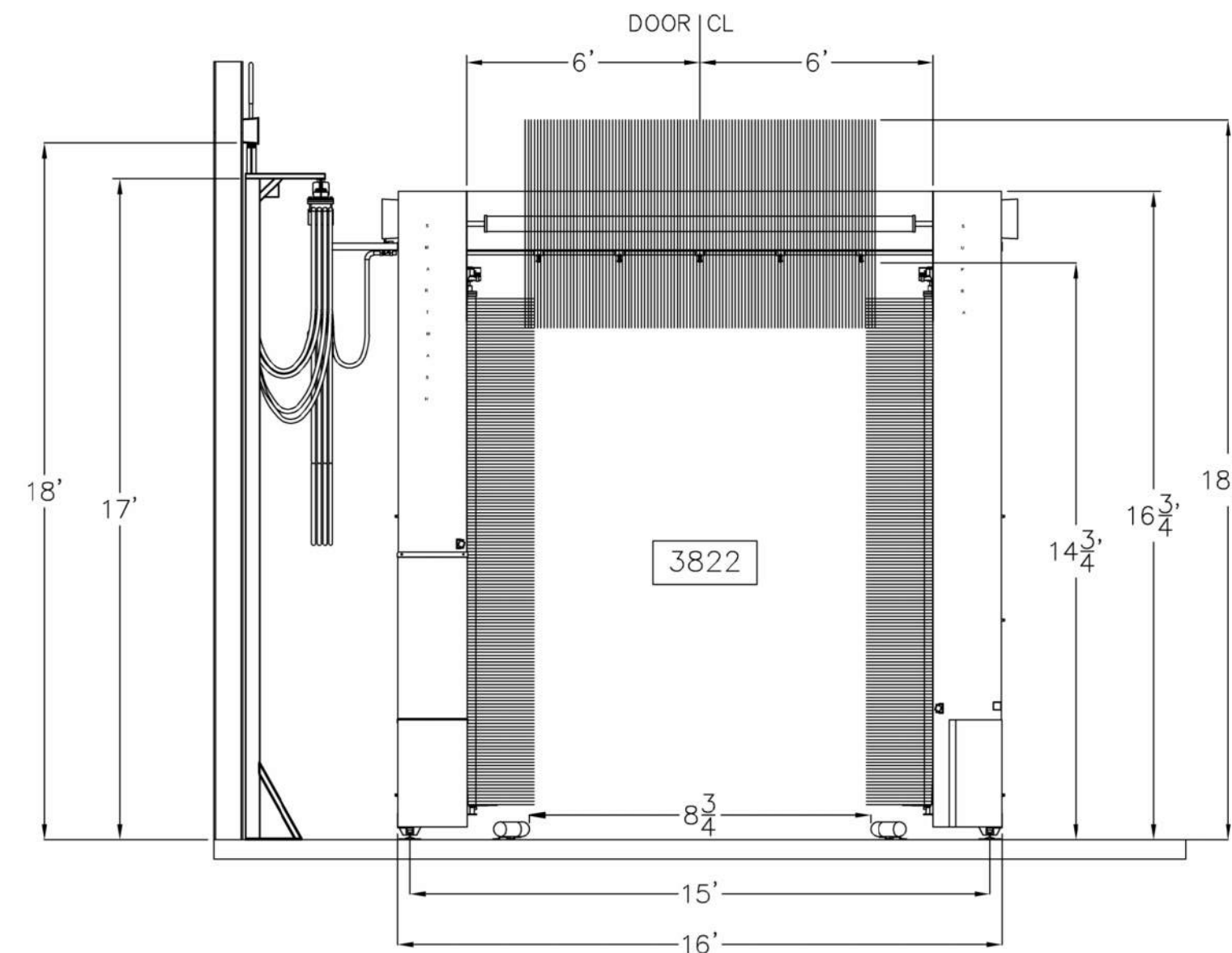

2 GANTRY WASH ELEVATION

NOTES:
4 DIGIT MARK NUMBERS WITH OR WITHOUT ALPHA EXTENSION REPRESENT NEW EQUIPMENT TO BE FURNISHED AND INSTALLED AS GRAPHICALLY INDICATED AND SHOWN IN SECTION 11000 SCHEDULES FOR EQUIPMENT.

ALL NEW EQUIPMENT SHOWN ON THESE DRAWINGS IS BASED ON SPECIFIED MANUFACTURER. ANY MODIFICATIONS AND / OR SUBSTITUTIONS OF SAID EQUIPMENT MUST BE COORDINATED BY THE CONTRACTOR INCLUDING ALL CONNECTIONS, SERVICES, OPENING SIZES, AND ANY OTHER CONSTRUCTION RELATED REQUIREMENTS.

VERIFY AND COORDINATE ALL STRUCTURAL, MECHANICAL, ELECTRICAL, AND PLUMBING REQUIREMENTS OF EQUIPMENT WITH MANUFACTURER PRIOR TO INSTALLATION.

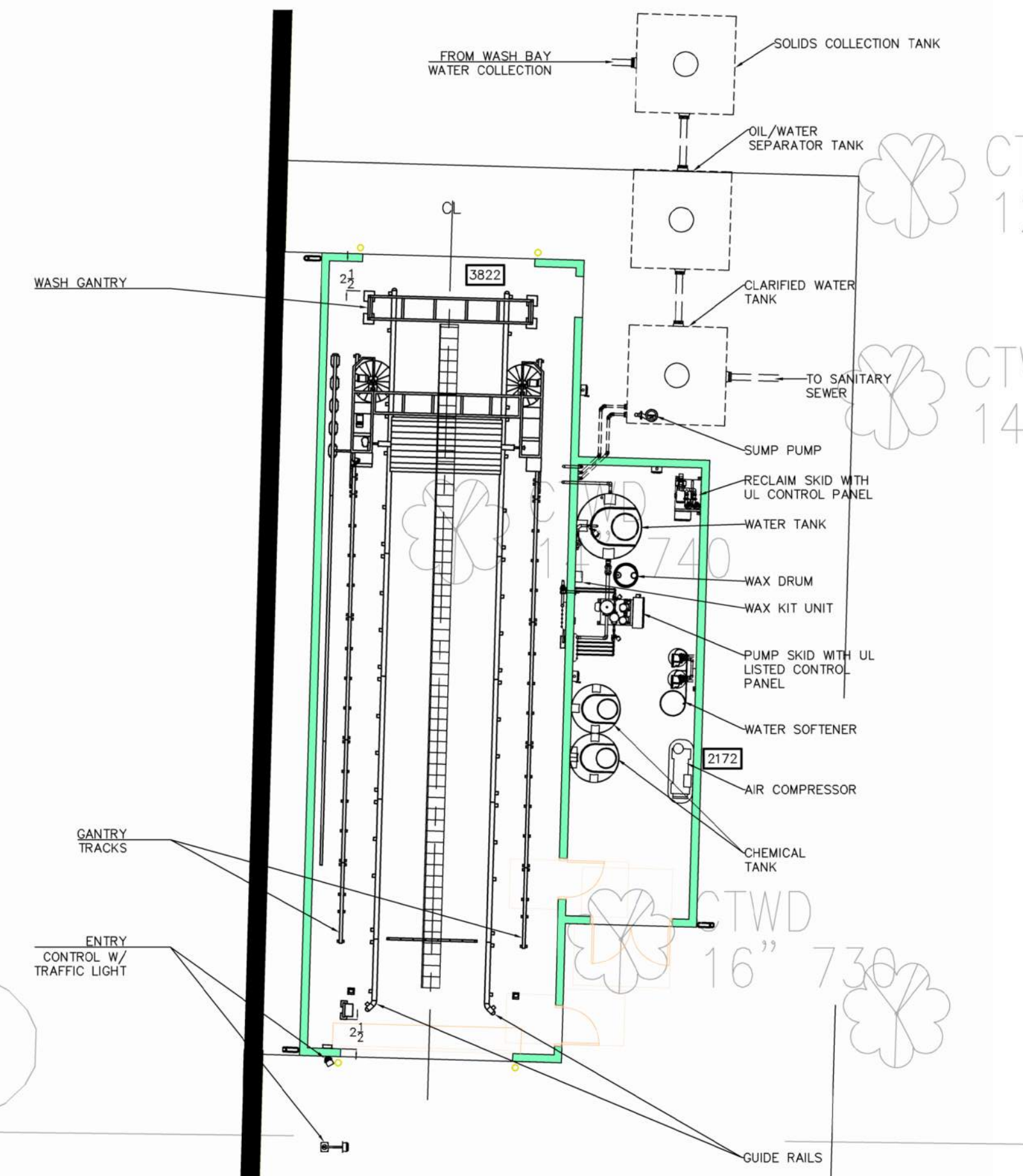

3 ENLARGED BUILDING PLAN

PRELIMINARY NOT FOR CONSTRUCTION

WSP USA, Inc.
1300 SW 5th Ave
Suite 3100
Portland, OR 97201
Tel: 1.503.274.8772



100% CONSTRUCTION DOCUMENTS

CITY OF WILSONVILLE

WILSONVILLE SMART EXPANSION

PROJECT NO:	REVISIONS:
DATE: 4/26/2024	ET
DRAWN:	MM
CHECKED:	

C200

PLUMBING FIXTURE SCHEDULE

GENERAL:
 A. ALL ROUGH-IN SIZES ARE MINIMUM CONNECTION SIZES. REFER TO DRAWINGS FOR FINAL SIZING.
 B. ALL VERTICAL WASTE RISERS TO FIXTURES AND ALL BELOW FLOOR WASTE PIPING SHALL BE A MINIMUM OF 2".

NOTES:
 1. LISTED FIXTURE AND TRIM ARE BASIS OF DESIGN. REFER TO SPECIFICATIONS FOR APPROVED ALTERNATE MANUFACTURERS. COORDINATE SUBSTITUTIONS WITH ARCHITECT/OWNER.

REFERENCE				ROUGH-IN				DESCRIPTION	TRIM	NOTES
ID-TAG	MANUFACTURER	MODEL	ADA	CW	HW	W	V			
FCO-1	ZURN	Z1400	N/A	-	-	SEE DWG	-	ADJUSTABLE FLOOR CLEANOUT, CAST IRON BODY, TAPERED THREAD PLUG AND ROUND NICKEL BRONZE SCORIATED CAST IRON HEAVY-DUTY SECURED TOP, ADJUSTABLE TO FINISHED FLOOR. OUTLET SIZE AS NOTED ON DRAWINGS.	N/A	1
FD-1	ZURN	Z415B-P	N	-	-	4"	2"	CAST IRON BODY FLOOR DRAIN, TYPE "B" 6" ROUND POLISHED NICKEL BRONZE STRAINER. OUTLET SIZE AS NOTED ON DRAWINGS.	PROVIDE WITH TRAP PRIMER 1/2" CONNECTIONS. REFER TO TP-1.	1
GCO-1	ZURN	Z1474	N/A	-	-	SEE DWG	-	GRADE CLEANOUT, ROUND, DURA-COATED CAST IRON, SIZE AS INDICATED, DOUBLE FLANGED HOUSING, HEAVY DUTY SECURED SCORIATED DURA-COATED CAST IRON COVER, LIFTING DEVICE, BRONZE CLEANOUT PLUG WITH GAS/WATER-TIGHT SEAL.	N/A	1
RPBP-1	WATTS	LF009	N/A	2 1/2"	-	-	-	BACKFLOW PREVENTER - REDUCED PRESSURE ZONE TYPE, BRONZE OR FDA APPROVED EPOXY COATED CAST IRON CONSTRUCTION, SIZE SAME AS CONNECTED PIPE, NON-CORROSIVE INTERNAL PARTS, STAINLESS STEEL SPRINGS, DIFFERENTIAL PRESSURE RELIEF VALVE BETWEEN SPRING-LOADED CHECK	BRONZE OR FDA APPROVED EPOXY COATED CAST IRON STRAINER UPSTREAM OF BACKFLOW PREVENTER, TO BE FURNISHED WITH BACKFLOW PREVENTER. PROVIDE TWO PRESSURE GAUGES, ONE ON EACH SIDE OF ASSEMBLY.	1
TD-1	TRENCHIFY	TPC600	N/A	-	-	4"	-	CLASS D RATED, DUCTILE IRON GRATE WITH LOCKING DEVICE	N/A	1
TP-1	PRECISION PLUMBING PRODUCTS	P1-500	N/A	1/2"	-	1/2"	-	MECHANICAL TRAP PRIMER, BRASS-PLATED CAP AND BODY, UPC/IAPMO LISTED. ACTIVATION WITH 10 PSIG PRESSURE DROP. SYSTEM OPERATING RANGE BETWEEN 20-80 PSI. 1/2" FIP INLET AND 1/2" MIP OUTLET.	N/A	1

SUMP PUMP SCHEDULE

NOTES:
 1. PROVIDE WITH WATERPROOF POWER CABLE, VERIFY FINAL LENGTH. CONFIRM LENGTH WHEN ORDERING.
 2. PROVIDE WITH INTEGRAL FLOAT SWITCH OR PIGGY BACK FLOAT.
 3. PROVIDE ZOELLER MODEL 10-4013 INDOOR ALARM WITH REED SENSOR.

REFERENCE				MECHANICAL DATA			ELECTRICAL				NOTES
ID TAG	MFR	MODEL	SERVES	CONFIGURATION	FLOW (GPM)	OPERATING PRESSURE (FT. HEAD)	MOTOR SIZE (HP)	VOLTAGE (V)	PHASE	FREQUENCY (HZ)	
SP-1	ZOELLER	95	RECLAIM TANKS	SINGLE	80	26	0.5	115	1	60	1,2

AIR COMPRESSOR AND DRYER SCHEDULE

NOTES:
 1. LISTED FIXTURE AND TRIM ARE BASIS OF DESIGN. REFER TO SPECIFICATIONS FOR APPROVED ALTERNATE MANUFACTURERS. COORDINATE SUBSTITUTIONS WITH ARCHITECT/OWNER.
 2. PROVIDE INTEGRAL DESICCANT AIR DRYER AND OTHER RELEVANT EQUIPMENT IN ORDER TO PROVIDE A FULLY FUNCTIONAL SYSTEM.

ID-TAG	MANUFACTURER	MODEL	DESCRIPTION	CAPACITY (CFM)	ELECTRICAL				NOTES
					MOTOR SIZE (HP)	VOLTAGE (V)	PHASE	FLA / MCA	
AC-1	SULLIVAN PALATEK	30D7	COMPLETE COMPRESSOR PACKAGE WITH MOUNTED DESICCANT AIR DRYER, HIGH EFFICIENCY COALESCING AIR FILTER, AND RECEIVER TANK.	115	30	208	3	77.4 / 96.8	1,2



REVISIONS:

#	DESCRP.	DATE
1	ADD-1	06/28/24